

University of California, Santa Barbara

**Construction Stormwater  
Best Management Practices**

May, 2009

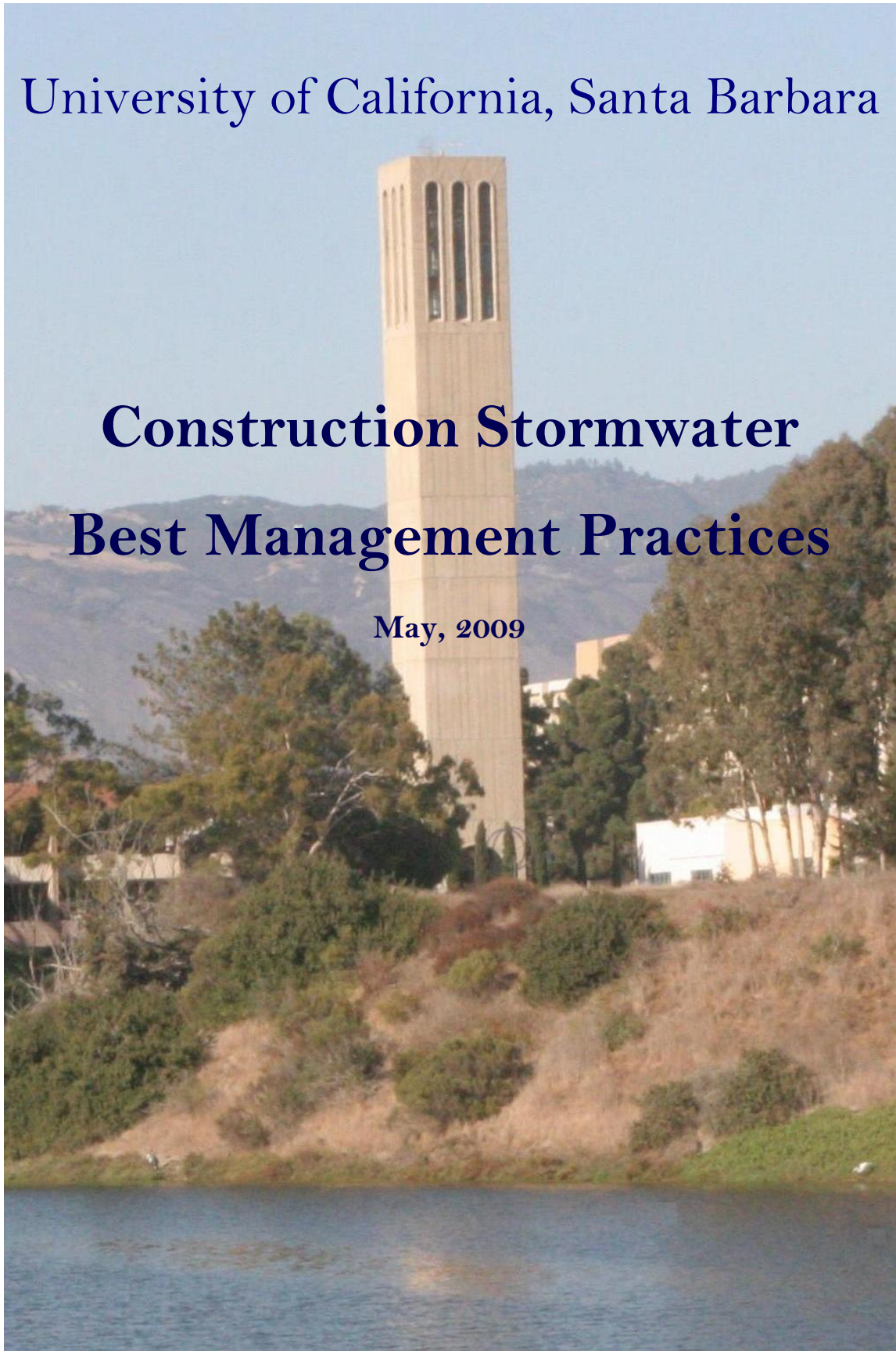

# Table of Contents

<u>Section</u>	<u>Page</u>
<b>Erosion Control (EC)</b>	
EC – 1      Scheduling of Activities	EC-1
EC – 2      Preserving Existing Vegetation	EC-2
EC – 3      Temporary Soil Stabilization: Erosion Control Blanket	EC-3
<b>Temporary Sediment Control (TSC)</b>	
TSC – 1      Cut Back Curb (Perimeter Control)	TSC-1
TSC – 2      Fiber Roll (Perimeter Control)	TSC-2
TSC – 3      Gravel Bag Berm (Perimeter Control)	TSC-5
TSC – 4      Stormdrain Inlet Protection (Secondary Control)	TSC-7
TSC – 5      Slope BMP: Fiber Roll or Gravel Bag	TSC-10
<b>Tracking Control (TC)</b>	
TC – 1      Stabilized Construction Entrance: Rumble Strips	TC-1
TC – 2      Sweeping and Vacuuming	TC-3
<b>Wind Erosion Control (WEC)</b>	
WEC – 1      Dust Control	WEC-1
<b>Non-Stormwater Management (NSM)</b>	
NSM – 1      Water Conservation	NSM-1
NSM – 2      Dewatering Operations	NSM-2
NSM – 3      Vehicle and Equipment Practices	NSM-5
NSM – 4      Illicit Connection/Illegal Discharge Detection	NSM-10
NSM – 5      Concrete Curing	NSM-12
NSM – 6      Concrete Finishing	NSM-13
NSM – 7      Paving and Grinding	NSM-14
NSM – 8      Potable Water/Irrigation	NSM-18
NSM – 9      Material Use	NSM-19
<b>Waste Management (WM)</b>	
WM – 1      Material Delivery and Storage	WM-1
WM – 2      Trash Containment	WM-4
WM – 3      Temporary Concrete Washout and Waste Management	WM-7
WM – 4      Sanitary Waste Management	WM-10
WM – 5      Stockpile Management	WM-12
WM – 6      Spill Prevention and Control	WM-14
WM – 7      Hazardous Waste Management	WM-18
WM – 8      Contaminated Soil Management	WM-22

## Erosion Control Introduction

Erosion control is any practice that protects the soil surface and prevents soil particles from being detached by rainfall or wind. The best way to minimize the risk of creating erosion and sedimentation problems during construction is to disturb as little of the land surface as possible. Other effective erosion control measures include: preserving existing vegetation where feasible, limiting disturbance, and stabilizing and re-vegetating disturbed areas as soon as possible. Particular attention must be paid to sites where the potential for soil exposure to the erosive effects of rainfall and wind is great and where there is potential for significant sediment discharge from the site to surface waters. Until permanent vegetation is established, soil cover is the most cost-effective and expeditious method to protect soil particles from detachment and transport by rainfall. Temporary soil stabilization can be the single most important factor in reducing erosion at construction sites. All inactive soil disturbed areas on the Project site and some active areas that are not experiencing high traffic, including relatively flat areas, must be protected from erosion. The Contractor is required to implement, at a minimum, the following applicable measures, or equivalent BMPs with the approval of the University's Representative.

### **EC – 1 Scheduling of Activities**

Involves developing a schedule or written plan that includes sequencing of construction activities with the implementation of construction site BMPs such as Erosion Controls and Temporary Sediment Controls. The purpose is to minimize the amount and duration of soil exposure to rain, wind, and vehicle tracking, and to perform the construction activities and control practices in accordance with the planned schedule.

### **EC – 2 Preserving Existing Vegetation**

Preserving existing vegetation is an inexpensive and effective way to prevent erosion. Leave existing vegetation at areas on site, such as along the site perimeter or adjacent to sensitive areas, where no construction activity is planned or will occur at a later date.

### **EC – 3 Temporary Soil Stabilization: Erosion Control Blankets**

Stabilize exposed soil to the Maximum Extent Practicable throughout the duration of the Project. BMPs such as mulch, temporary seeding, soil stabilizers, binders, temporary vegetation, straw, and erosion control blankets are used to protect or bind disturbed soil area from raindrop impact erosion, sheet erosion, and wind erosion. Erosion control blankets are used to stabilize and protect disturbed soil areas from erosion by water and wind.



# Erosion Control

## EC-1 Scheduling of Activities

Definition	Develop a schedule or written plan that includes sequencing of construction activities with the implementation of construction site BMPs such as Erosion Controls and Temporary Sediment Controls. Identify the rainy season. Avoid grading during the rainy season to the Maximum Extent Practicable.
Purpose	Minimize the amount and duration of soil exposure to rain, wind, and vehicle tracking, and to perform the construction activities and control practices in accordance with the planned schedule.
Conditions Where the Practice Applies	Sites where construction activities might affect water quality. Appropriate BMPs shall be implemented during both rainy and non-rainy seasons.
Specifications: Design and Installation	<ul style="list-style-type: none"> <li>• Design a schedule showing each phase of construction.</li> <li>• Develop the sequencing and timetable for the start and completion of each item such as site clearing and grubbing, grading, excavation, paving, pouring foundation, installing utilities, etc. to minimize the active construction area during the rainy season. Include all activities in the schedule.</li> <li>• Monitor the weather forecast for rainfall.</li> </ul>
Maintenance & Inspection	<ul style="list-style-type: none"> <li>• Follow the construction sequence throughout the Project.</li> <li>• Modify the SWPPP/Questionnaire and/or map before any changes in construction activities are executed.</li> <li>• Update the SWPPP/Questionnaire if a site inspection indicates the need for additional erosion and sediment control.</li> </ul>

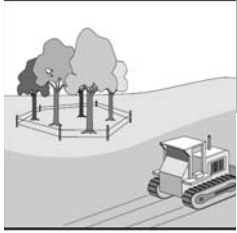

# Erosion Control

## EC-2 Preserving Existing Vegetation

Definition	Preserving existing vegetation is the identification and protection of desirable vegetation that provides erosion and sediment control benefits.
Purpose	Reduce stormwater runoff by intercepting rainfall, protecting soil surface from the impact of raindrops, hold soil particles in place, and prevent sediments and other pollutants from leaving the site.
Conditions Where the Practice Applies	<ul style="list-style-type: none"> <li>• Where vegetation exists in the predevelopment condition.</li> <li>• Areas within the site where no construction activity occurs or will not occur until a later date.</li> <li>• Site perimeter and adjacent to sensitive areas such as water bodies, wetlands, ocean, storm drains, etc.</li> </ul>
Specifications: Design and Installation	<ul style="list-style-type: none"> <li>• During pre-construction protect trees and roots, delineate vegetation areas to be protected, identify vegetative buffers.</li> <li>• Do not cut tree roots inside the tree drip line.</li> <li>• Use barriers to prevent equipment from approaching protected areas.</li> <li>• Identify vegetative buffers and mark them on the BMP Site Map.</li> <li>• When used as a perimeter control the vegetated buffer needs to be at a minimum of 3-4 feet in width (from perimeter to the interior of the site). Maintain vegetation to continue its effectiveness as a perimeter BMP.</li> </ul>
Maintenance & Inspection	<ul style="list-style-type: none"> <li>• Inspect BMPs prior to forecast rain, daily during extended rain events, after rain events, and weekly throughout the life of the Project.</li> <li>• If a protective fence was installed around the vegetation, ensure it is being maintained.</li> <li>• Inspect vegetative buffers and their effectiveness. Suggest other BMP if no longer effective.</li> </ul>



# Erosion Control

## EC-3 Temporary Soil Stabilization: Erosion Control Blanket

Definition	The application of erosion control blankets, geotextiles, or plastic covers on the soil surface to stabilize disturbed soil areas and protect soils from erosion by wind and water.
Purpose	To protect and temporarily stabilize the soil surface from the forces of raindrop impact, wind erosion, and overland stormwater flow throughout the duration of the Project.
Conditions Where the Practice Applies	These measures are used in areas of disturbed soil, sloped areas, and stockpiles.
Specifications: Design and Installation	<p><u>Material</u> <i>Erosion Control Blankets</i></p> <p>Biodegradable rolled erosion control products are typically composed of jute fibers, curled wood fibers, straw, coconut fiber, or a combination of these materials.</p> <ul style="list-style-type: none"> <li>• Jute <ul style="list-style-type: none"> <li>• Natural fiber made into a yarn and loosely woven into a mesh.</li> <li>• Supplied in rolled strips.</li> <li>• Secure in place with wire staples made of 12 inch steel wire, U-shaped with 8inch legs and 2 inch crown.</li> </ul> </li> <li>• Excelsior (Curled Wood Fiber) <ul style="list-style-type: none"> <li>• Blanket material shall consist of machine produced mats of curled wood excelsior with 80% of the fiber 6 inch or longer.</li> <li>• Shall be of consistent thickness and evenly distributed over the entire area of the blanket.</li> <li>• Furnished in rolled strips, minimum of 48 inch wide, and have an average weight of 12 lb/ft<sup>2</sup>.</li> <li>• Secure in place with wire staples made of 12 inch steel wire, U-shaped with 8 inch legs and 2 inch crown.</li> </ul> </li> <li>• Straw Blanket <ul style="list-style-type: none"> <li>• Machine produced mats of straw with a lightweight biodegradable netting top layer.</li> <li>• Shall be of consistent thickness and evenly distributed over the entire area of the blanket.</li> <li>• Furnished in rolled strips, minimum 6.5 feet weed, minimum 80 feet long, and a minimum 6.4 lb/ft<sup>2</sup>.</li> <li>• Secure in place with wire staples made of 12 inch steel wire, U-shaped with 8 inch legs and 2 inch crown.</li> </ul> </li> </ul>

Sources include EPA, SWRCB, Caltrans, CASQA  
**Erosion Control**



# Erosion Control

## EC-3 Temporary Soil Stabilization: Erosion Control Blanket

- Coconut Fiber Blanket
  - Machine produced mats of 100% coconut fiber with biodegradable netting on the top and bottom.
  - Shall be of consistent thickness and evenly distributed over the entire area of the blanket.
  - Furnished in rolled strips, minimum 6.5 feet wide, minimum 80 feet long, and a minimum 6.4 lb/ft<sup>2</sup>.
  - Secure in place with wire staples made of 12 inch steel wire, U-shaped with 8 inch legs and 2 inch crown.

### *Geotextiles*

- Material shall be a woven polypropylene fabric with minimum thickness of 0.06 inch, minimum width of 12 feet, and shall have a minimum tensile strength of 150 lbs (warp) 80 lbs (fill) in conformance with ASTM Designation: D4632.
- The permittivity of the fabric shall be approximately 0.07 sec-1 in conformance with ASTM Designation: D4491.
- The fabric shall have an ultraviolet stability of 70% in conformance with ASTM Designation: D4355.
- Secure in place with wire staples made of 12 inch steel wire, U-shaped with 8 inch legs and 2 inch crown.
- May be reused if, in the opinion of the University's representative, they are suitable for the use intended.

### *Plastic Covers*

- Composed of polypropylene, polyethylene, nylon, or other synthetic fibers.
- Minimum thickness of 6 mils.
- Anchor with staples or gravel bags no more than 10 feet apart
- Seams must be taped or weighted down their entire length, and there should be at least a 12 inches to 24 inches overlap of all seams. Edges should be embedded a minimum of 6 inches.

### Site Preparation

- Grade or shape area of installation.
- Remove all rocks, clods, vegetation or other obstructions so that the installed blankets or mats will have complete, direct contact with the soil.

### Anchoring

- U-shaped wire staples, metal geotextile stake pins, or triangular wooden stakes can be used to anchor mats and blankets to the ground surface.
- Staples shall be made of 12 inch steel wire, U-shaped with 8 inch legs and 2 inch crown.

Sources include EPA, SWRCB, Caltrans, CASQA

**Erosion Control**



# Erosion Control

## EC-3 Temporary Soil Stabilization: Erosion Control Blanket

- Metal stake pins shall be made of 0.188 inches diameter steel with a 1.5 inch steel washer at the head of the pin.
- Wire staples and metal stakes shall be driven flush to the soil surface.
- All anchors shall be 6 inches to 18 inches long and have sufficient ground penetration to resist pullout. Longer anchors may be required for loose soil.

### Installation on Slopes

Installation shall be in accordance with the manufacturer's recommendations. In general, these will be as follows:

- Begin at the top of the slope and anchor the blanket in a 6 inch deep by 6 inch wide trench. Backfill trench and tamp earth firmly.
- Unroll blanket down slope in the direction of water flow.
- Overlap the edges of adjacent parallel rolls 2 inches to 3 inches and staple every 3feet.
- When blankets must be spliced, place blankets end over end (shingle style) with 6 inch overlap. Staple through overlapped area, approximately 12 inches apart.
- Lay blankets loosely and maintain direct contact with the soil. Do not stretch.
- Staple blankets sufficiently to anchor blanket and maintain contact with the soil. Staples shall be placed down the center and staggered with the staples placed along the edges. Steep slopes, 1:1 (V:H), require a minimum of 2 staples/yd<sup>2</sup>. Moderate slopes, 1:2 (V:H) to 1:3 (V:H), require a minimum of 1.5 staples/yd<sup>2</sup>, placing 1 staple/yd on centers. Gentle slopes require a minimum of 1 staple/ yd<sup>2</sup>.

### Maintenance & Inspection

Areas treated with temporary soil stabilization shall be maintained to provide adequate erosion control. Temporary soil stabilization shall be reapplied or replaced on exposed soils when area becomes exposed or exhibits visible erosion.

- Inspect BMPs prior to forecast rain, daily during extended rain events, after rain events, and weekly throughout the life of the Project.
- All blankets and mats shall be inspected periodically after installation.
- Inspect blankets regularly for cracks, tears, or breaches, in the fabric. If so, repair or replace the fabric immediately
- Installation shall be inspected after significant rain storms to check for erosion and undermining. Any failures shall be repaired immediately.
- If washout or breakage occurs, re-install the material after repairing the damage to the slope or channel.
- Make sure matting is uniformly in contact with the soil. The surface should be smooth with minimal soil loss. If covered with sediment, replace immediately.
- Check that staples and fasteners are flush with the ground and that they held the blanket in place.

Sources include EPA, SWRCB, Caltrans, CASQA

**Erosion Control**





# Erosion Control

## EC-3 Temporary Soil Stabilization: Erosion Control Blanket

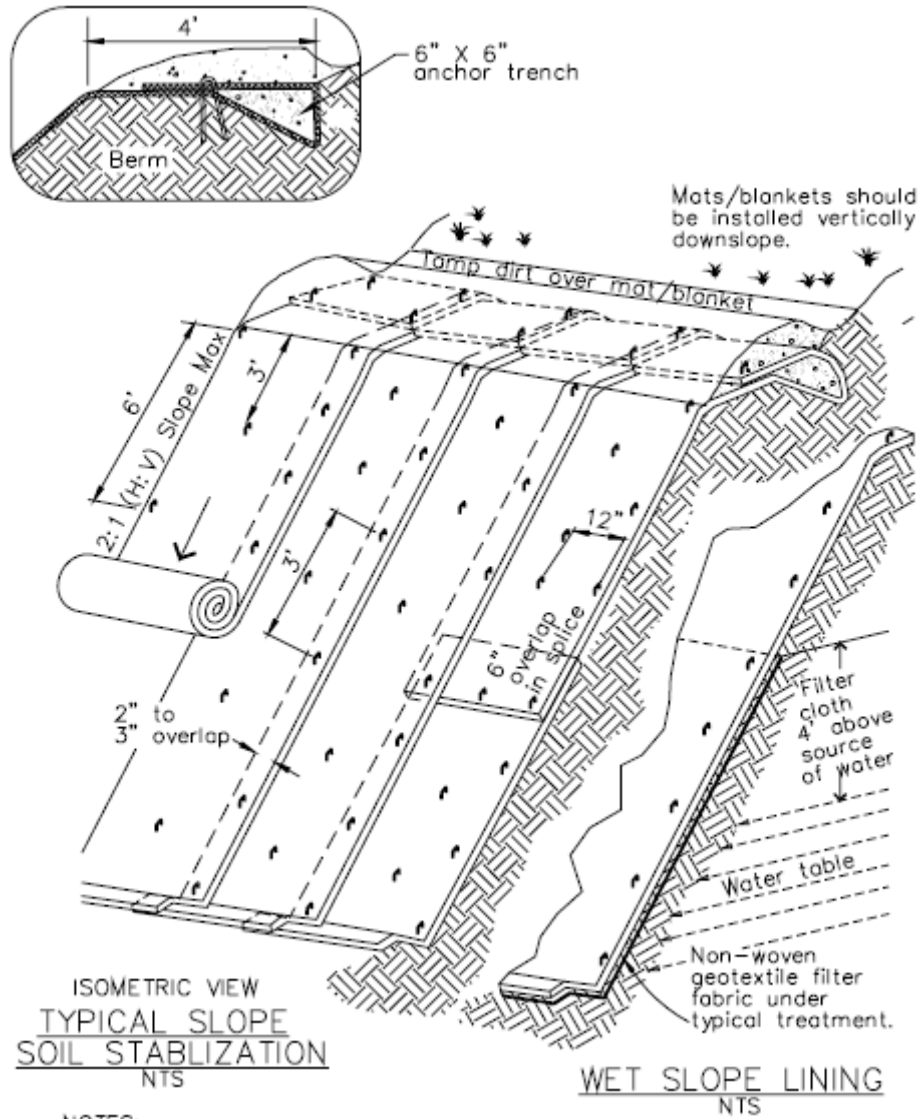

**Figure 2**

Notes:

1. Slope surface shall be free of rocks, clods, sticks, and vegetation. Mats/blankets shall have good soil contact.
2. Lay blankets loosely and stake or staple to maintain direct contact with the soil. Do not stretch.
3. Install per manufacturer's recommendations.

## Temporary Sediment Control Introduction

Temporary sediment controls generally involve intercepting sediment-laden runoff, slowing the flow, and allowing the suspended sediment particles to drop out of suspension. Sediment control BMPs should be the secondary means of preventing stormwater contamination. Sediment control techniques should be used to capture any soil that becomes eroded, in case erosion control techniques are ineffective. These techniques consist of installing perimeter controls (such as cut back curbs, fiber rolls, or gravel bag berms), providing fiber rolls or gravel bag berms to break up slope length or flow, and installing secondary controls such as stormdrain inlet protection to ensure contamination does not enter waters of the U.S.. All new and existing roadways, curbs, and gutters must be protected from sediment-laden runoff, are considered as perimeters of the site, and will need perimeter controls installed. The Contractor is required to implement, at a minimum, the following applicable measures, or equivalent BMPs with the approval of the University's Representative.

### **TSC – 1 Cut Back Curb (Perimeter Control)**

A temporary sediment trap formed by excavation behind the curb. This control measure is one of a few perimeter controls whose purpose is to intercept sediment-laden runoff from the site during construction and retain sediment on the lot.

### **TSC – 2 Fiber Roll (Perimeter Control)**

A fiber roll consists of fibers from straw, flax, or other similar materials rolled or bound into a tight tubular roll and placed along the site boundary to act as a perimeter control or on the toe and face of slopes to intercept runoff and reduce the flow velocity. The fiber roll is used to intercept sediment-laden water and prevent the sediment and associated pollutants from entering the street and the stormwater system.

### **TSC – 3 Gravel Bag Berm (Perimeter Control)**

A gravel bag berm consists of a single row of gravel bags that are installed end to end to form a barrier along the site boundary to act as a perimeter control or across a slope to intercept sediment-laden runoff and reduce flow velocity.

### **TSC – 4 Stormdrain Inlet Protection (Secondary Control)**

Devices used at stormdrain inlets that are subject to runoff from construction activities to detain and/or filter sediment-laden runoff to allow sediment to settle and/or filter sediment prior to discharge into storm drainage systems or watercourses.

### **TSC – 5 Slope BMP: Fiber Roll or Gravel Bag**

Devices, such as fiber rolls and/or gravel bags, installed on the toe and face of slopes to break up slope length and reduce the flow velocity.

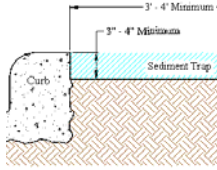

# Temporary Sediment Control

## TSC-1 Cut Back Curb

Definition	A temporary sediment trap formed by excavation behind the curb.
Purpose	Intercept sediment-laden runoff from the site during construction and retain sediment on site. The hardscape (sidewalk, curb, or roadway) acts as a barrier to retain the stormwater long enough for the sediment to drop out of the stormwater before it leaves the site.
Conditions Where the Practice Applies	A cutback curb is installed as a perimeter control when there is hardscape, such as a curb, sidewalk, or roadway, near the perimeter of the site. All new and existing roadways, curbs, and gutters must be protected from sediment-laden runoff, and will need perimeter controls installed. This control measure should not be used if there is no hardscape near the perimeter of the site.
Specifications: Design and Installation	Excavate soil from behind the curb, sidewalk, or roadway 3-4 inches down from the top of the hardscape and bring the soil back 3-4 feet back from the hardscape. The depth and length of the excavated area may be increased if more sediment storage is needed.
Maintenance & Inspection	<ul style="list-style-type: none"> <li>• Inspect BMPs prior to forecast rain, daily during extended rain events, after rain events, and weekly throughout the life of the Project.</li> <li>• The excavated area must be cleaned regularly as site conditions or rain events cause sediment deposition in the excavated area. Inspect this control measure to ensure the excavated area is at a minimum of 3-4 inches in depth and has a width of at a minimum of 3-4 feet.</li> </ul>



# Temporary Sediment Control

## TSC-2 Fiber Roll

Definition	A fiber roll consists of wood excelsior, rice or wheat straw, or coconut fibers that is rolled or bound into a tight tubular roll. Fiber rolls can be used as a perimeter control and placed along the site perimeter to contain pollutants on site, they can be placed on the toe and face of slopes to intercept runoff and reduce flow velocity, and they can also be used around temporary stockpiles.
Purpose	As a perimeter control, the fiber roll is used to intercept sediment-laden stormwater and prevent the sediment and associated pollutants from entering the street and the stormwater system. For specifications regarding fiber roll use on slopes, please refer to TSC – 5 Slope BMP: Fiber Roll or Gravel Bag. For specifications regarding fiber roll use around temporary stockpiles, please refer to WM – 5 Stockpile Management.
Conditions Where the Practice Applies	As a perimeter control, fiber roll can be used anywhere along the site perimeter as long as it can be entrenched or staked in place. All new and existing roadways, curbs, and gutters must be protected from sediment-laden runoff, are considered as perimeters of the site, and will need perimeter controls installed.
Specifications: Design and Installation	<ul style="list-style-type: none"> <li>• Fiber rolls should be prefabricated rolls.</li> <li>• Place fiber rolls into a 2 to 4 inch trench.</li> <li>• Stake or tie fiber rolls into place.</li> <li>• Tied fiber rolls staking is spaced at 2 feet apart.</li> <li>• Stake in the center of the fiber roll, spacing at 2 feet apart.</li> <li>• Use wood stakes with a nominal classification of 0.75 by 0.75 inch and minimum length of 24 inches.</li> <li>• If more than one fiber roll is placed in a row, the rolls should be overlapped, not abutted.</li> <li>• Drive stakes at the end of each fiber roll. If fiber rolls are overlapped, stake through both overlapped fiber rolls.</li> </ul>
Maintenance & Inspection	<ul style="list-style-type: none"> <li>• Inspect BMPs prior to forecast rain, daily during extended rain events, after rain events, and weekly throughout the life of the Project.</li> <li>• Repair or replace split, torn, unraveling, flattened, or slumping fiber rolls.</li> <li>• Remove the sediment after it reaches 1/3 height of the fiber roll. Dispose of sediment in a proper place that will not allow contamination of the stormwater system.</li> <li>• Properly dispose of the fiber roll if it has been damaged or is no longer needed and cannot be reused.</li> </ul>

Sources include EPA, SWRCB, Caltrans, CASQA  
**Temporary Sediment Control**



# Temporary Sediment Control

## TSC-2 Fiber Roll

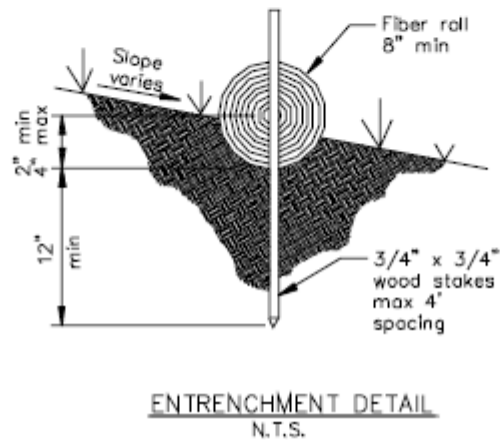
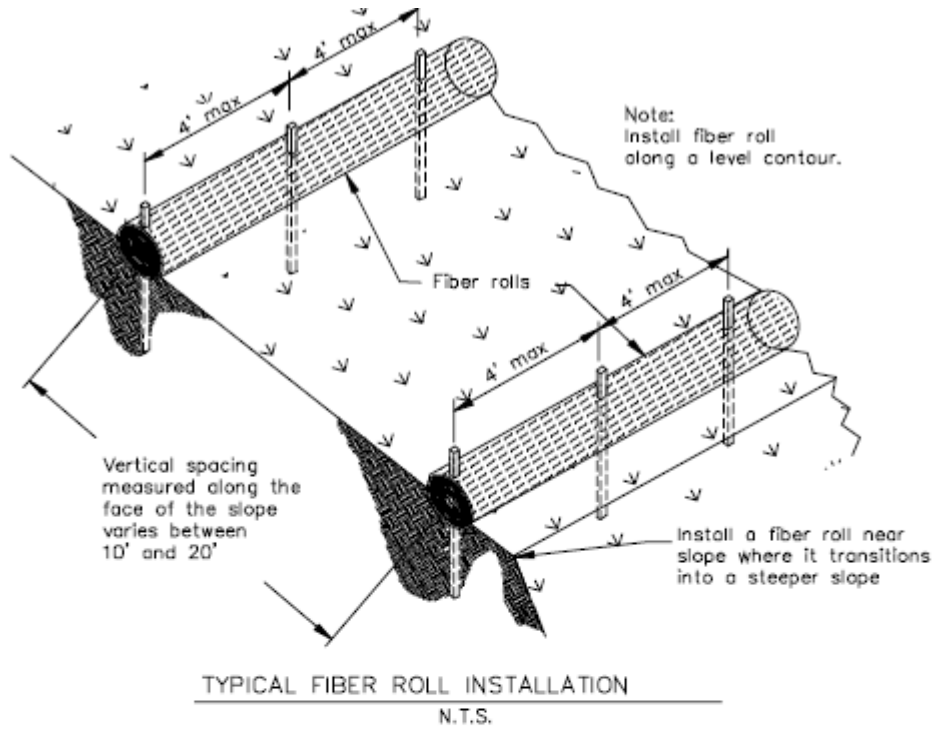

Sources include EPA, SWRCB, Caltrans, CASQA  
**Temporary Sediment Control**



# Temporary Sediment Control

## TSC-2 Fiber Roll

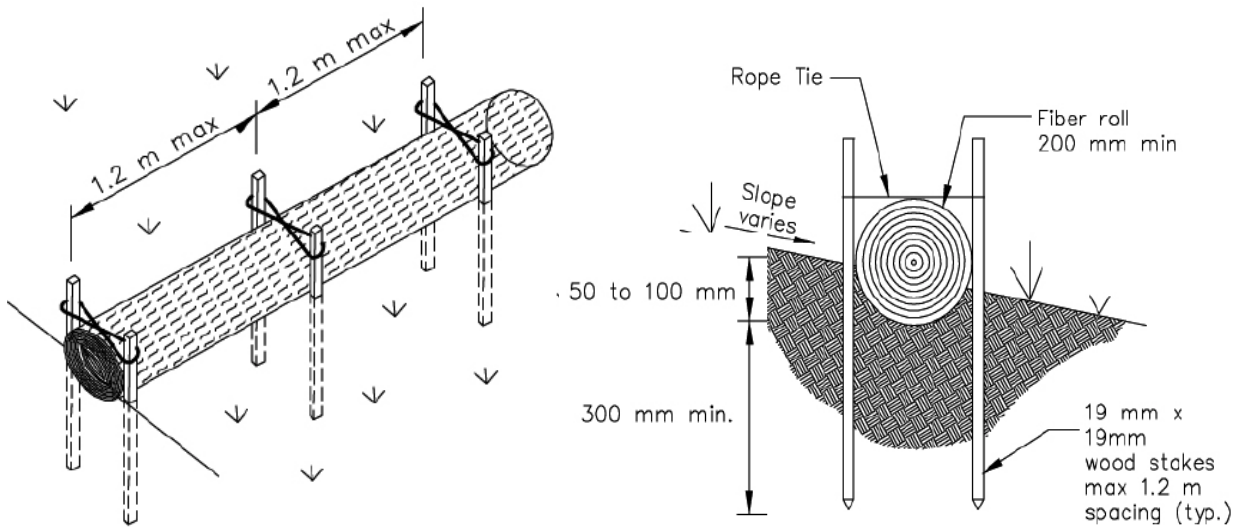
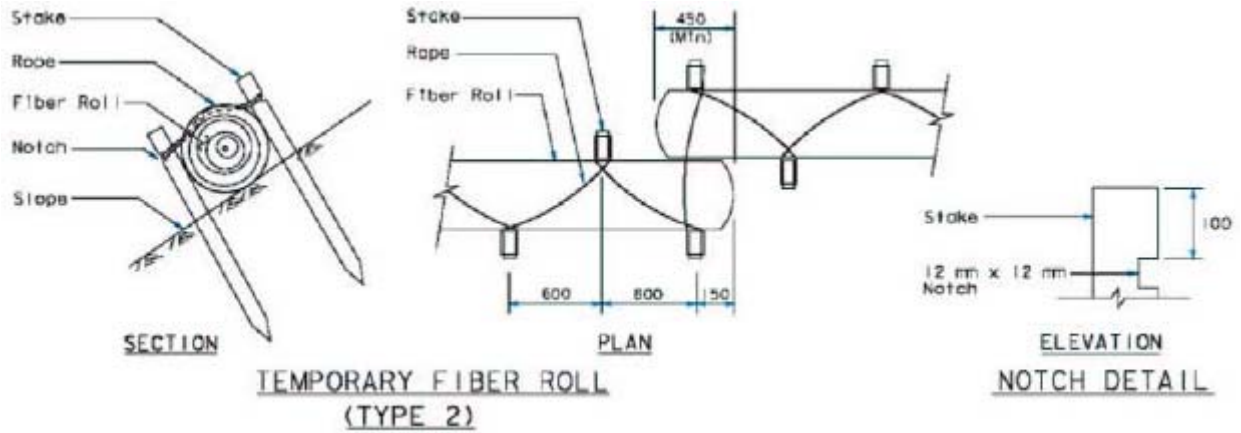

Sources include EPA, SWRCB, Caltrans, CASQA  
**Temporary Sediment Control**

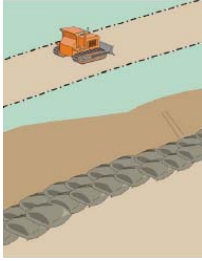

# Temporary Sediment Control

## TSC-3 Gravel Bag Berm

Definition	A gravel bag berm consists of a series of gravel-filled bags made of a woven polypropylene geotextile fabric abutted end to end to form a berm. Gravel bag berms can be used as a perimeter control and placed along the site perimeter to contain pollutants on site, they can be placed on the toe and face of slopes to intercept runoff and reduce flow velocity, and they can also be used around temporary stockpiles.
Purpose	As a perimeter control, the gravel bag berm is used to intercept sediment-laden stormwater and prevent the sediment and associated pollutants from entering the street and the stormwater system. For specifications regarding gravel bag berm use on slopes, please refer to TSC – 5 Slope BMP: Fiber Roll or Gravel Bag. For specifications regarding gravel bag berm use around temporary stockpiles, please refer to WM – 5 Stockpile Management.
Conditions Where the Practice Applies	As a perimeter control, gravel bag berms can be used anywhere along the site perimeter, even on impermeable surfaces. All new and existing roadways, curbs, and gutters must be protected from sediment-laden runoff, are considered as perimeters of the site, and will need perimeter controls installed.
Specifications: Design and Installation	<p><u>Gravel Bags</u></p> <ul style="list-style-type: none"> <li>• Bags shall be woven polypropylene, polyethylene, or polyamide fabric.</li> <li>• Minimum unit weight of 8 ounces per square yard.</li> <li>• Burst strength exceeding 200 lbs in conformance with ASTM designation D4632.</li> <li>• Ultraviolet stability exceeding 70% in conformance with ASTM designation D4355.</li> <li>• Each gravel-filled bag shall have a length of 24-32 inches, width of 16-20 inches, and mass of approximately 30-50 lbs.</li> <li>• Fill material shall be between 3/8 and 1 inch in diameter.</li> <li>• Fill material shall be free from clay balls, organic matter, sand or silt, and other deleterious material.</li> </ul> <p><u>Installation Requirements</u></p> <ul style="list-style-type: none"> <li>• Install along a level contour.</li> <li>• Clear bedding area of obstructions one inch in diameter or larger.</li> <li>• Place in single layer with ends abutted tightly and not overlapped.</li> <li>• Use in conjunction with temporary soil stabilization.</li> </ul>

Sources include EPA, SWRCB, Caltrans, CASQA  
**Temporary Sediment Control**

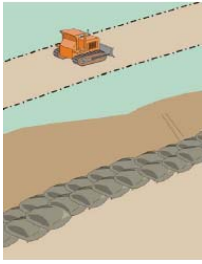

# Temporary Sediment Control

## TSC-3 Gravel Bag Berm

### Maintenance & Inspection

- Inspect BMPs prior to forecast rain, daily during extended rain events, after rain events, and weekly throughout the life of the Project.
- Gravel bags exposed to sunlight will need to be replaced every two to three months due to degradation of the bags.
- Reshape or replace gravel bags as needed.
- Repair washouts or other damage as needed. Split or torn gravel bags must be repaired, if possible, or replaced.
- Inspect gravel bag berms for sediment accumulation. Sediment that accumulates in the BMP must be periodically removed in order to maintain BMP effectiveness. Sediment should be removed when the sediment accumulation reaches one-third of the barrier height. Sediment removed during maintenance must be disposed of in a proper place that will not allow contamination of the stormwater system.
- Properly dispose of gravel bags that have been damaged or are no longer needed and cannot be reused.



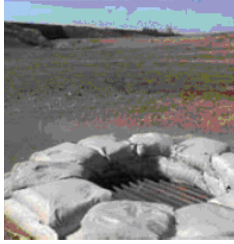

# Temporary Sediment Control

## TSC-4 Stormdrain Inlet Protection

Definition	A device used at stormdrain inlets that is subject to runoff from construction activities to detain sediment-laden runoff and allow sediment to settle and prevent it from entering the stormdrain system.
Purpose	Prevent sediment and pollutants from entering the stormdrain system and the waters of the U.S..
Conditions Where the Practice Applies	Near any stormdrain inlet that has the potential to be subject to runoff from construction activities.
Specifications: Design and Installation	First, identify all existing and/or planned stormdrain inlets within the active construction Project and also outside the Project areas that have the potential to receive stormwater runoff from the construction site. Determine which of the following stormdrain inlet protections will work best for each existing and proposed inlet.

### Cutback Curb Stormdrain Inlet Protection

- May be used in the interior of the site in areas that have not been paved.
- Excavate the soil around the inlet 3-4 inches down and bring the soil 3-4 feet back from around the inlet. This will create a sediment trap 3-4 inches deep and 3-4 feet in length around the stormdrain inlet. See Figure 1 at the end of this BMP Specification.
- Install a permeable fence such as orange mesh around the perimeter of the cutback to prevent traffic near the stormdrain inlet and to retain the integrity of the BMP.
- May also use gravel bags around the top of the stormdrain inlet in areas susceptible to high stormwater flows. Do not cover the grate of the stormdrain inlet; stormwater must be allowed to flow through the stormdrain inlet. See TSC-3 Gravel Bag Berm for gravel bag material and fill specifications.

### Gravel Bag Barrier for Curb Stormdrain Inlets

- May be used around curb stormdrain inlets.
- Construct gravel bags in accordance with the BMP Figure 2.
- See TSC-3 Gravel Bag Berm for gravel bag material and fill specifications.
- Flows shall not overtop curb.
- Ponded water shall not encroach on the public roadway.
- If necessary, install traffic cones around the gravel bag barrier to prevent traffic damaging the BMP.
- Determine which direction the flow will enter the curb stormdrain inlet. Construct the gravel bag barrier on the side the flow will enter the stormdrain. If the surface is relatively flat and stormwater flow can enter the drain from either

Sources include EPA, SWRCB, Caltrans, CASQA  
**Temporary Sediment Control**

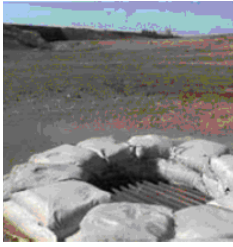

# Temporary Sediment Control

## TSC-4 Stormdrain Inlet Protection

side, construct a gravel bag barrier on both sides of the curb stormdrain inlet.

- Construct the gravel bag barrier in the shape of an L with the short edge closest to the curb stormdrain inlet and the long edge closest to and running parallel along the street.
  - The short edge will consist of 5 gravel bags. Place two gravel bags, one on top of the other, abutted to the curb and running lengthwise toward the street. Place another gravel bag abutted to the other two also running lengthwise toward the street, followed by two more gravel bags stacked on top of each other running in the same direction.
  - The long edge will consist of 12 gravel bags: 6 stacks of 2. Place the first stack abutted to the short edge on the street side. The 6 stacks of 2 gravel bags will run lengthwise parallel to the street. Refer to the BMP drawing at the end of this BMP Spec Sheet.
  - The gravel bag barrier will be constructed so stormwater will flow into the barrier and will be detained to allow the sediment to settle before the stormwater flows through the spillway and into the curb stormdrain inlet.

### Gravel Bag Barrier for Street Stormdrain Inlet

- May be used around street stormdrain inlets.
- Construct gravel bags in accordance with the BMP drawing at the end of this BMP Spec Sheet.
- See TSC-3 Gravel Bag Berm for gravel bag material and fill specifications.
- Construct the gravel bag barrier by placing gravel bags around the entire edge of the street stormdrain inlet. Place stacks of 2 gravel bags stacked one on top of the other around the perimeter of the street stormdrain inlet. Do not block the street stormdrain inlet by placing gravel bags on the grate.
- If necessary, install traffic cones around the gravel bag barrier to prevent traffic damaging the BMP.

Do not place filter fabric underneath the inlet grate (or wrap it around the inlet grate) since the collected sediment may fall into the drain inlet when the fabric is removed and because clean stormwater still needs to be allowed to drain.

### Maintenance & Inspection

- Inspect BMPs prior to forecast rain, daily during extended rain events, after rain events, and weekly throughout the life of the Project.
- Inspect all stormdrain inlets after rain events to check for bypassed material.
- Inspect cutback curb stormdrain inlet protection for excess sediment. Remove excess sediment and maintain specific BMP dimensions: sediment level should be 3-4 inches from the stormdrain inlet and 3-4 feet back.
- Inspect gravel bag barriers for curb and street stormdrain inlets. Make sure all sediment is removed from the barrier and from inside the stormdrain inlet, and the gravel bags are intact and are positioned properly.

Sources include EPA, SWRCB, Caltrans, CASQA

**Temporary Sediment Control**

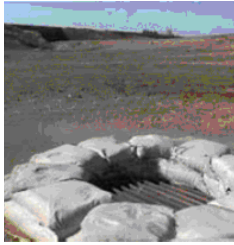

# Temporary Sediment Control

## TSC-4 Stormdrain Inlet Protection



Figure 1 Cutback Curb Stormdrain Inlet Protection

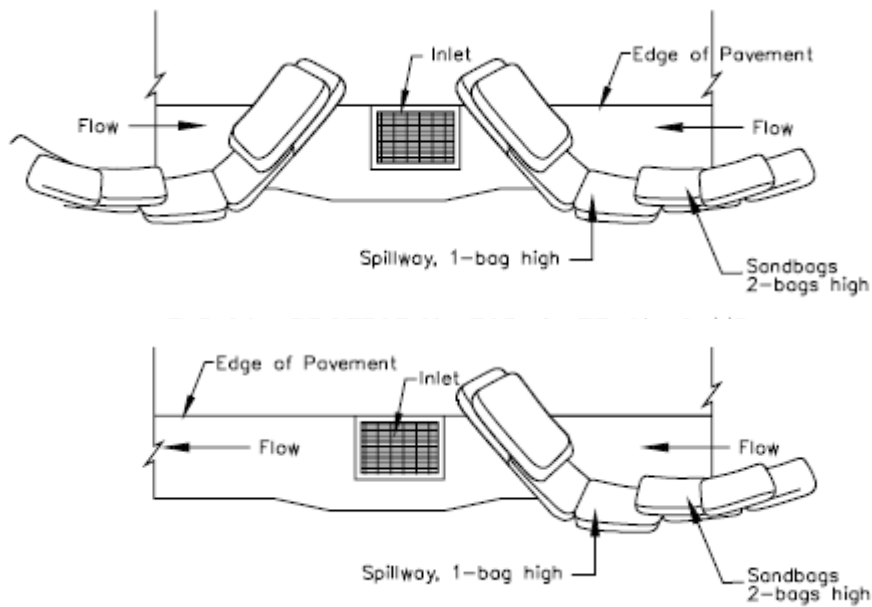

Figure 2 Gravel Bag Barrier for Curb Stormdrain Inlets



Figure 3 Gravel Bag Barrier for Street Stormdrain Inlets

Sources include EPA, SWRCB, Caltrans, CASQA  
Temporary Sediment Control



# Temporary Sediment Control

## TSC-5 Slope BMP: Fiber Roll or Gravel Bag Berm

Definition	A fiber roll consists of wood excelsior, rice or wheat straw, or coconut fibers that is rolled or bound into a tight tubular roll. A gravel bag berm consists of a series of gravel-filled bags made of a woven polypropylene geotextile fabric abutted end to end to form a berm. Fiber rolls and gravel bags can be placed on the toe and face of slopes to intercept runoff and reduce flow velocity.
Purpose	The fiber rolls and/or gravel bag berms are placed along the toe, top, face, and at grade of exposed and erodible slopes to shorten slope length, to reduce stormwater flow velocity, and to break up stormwater sheet flow.
Conditions Where the Practice Applies	Fiber rolls and gravel bag berms can be placed along the toe, top, face, and at grade of exposed and erodible slopes.
Specifications: Design and Installation	For breaking up slope length, fiber rolls and/or gravel bag berms spacing is based on slope inclination: <ul style="list-style-type: none"> <li>• 1:4 or flatter – spacing shall be placed 20 feet apart.</li> <li>• 1:4 to 1:2 – spacing shall be 15 feet apart.</li> <li>• 1:2 or greater – spacing shall be 10 feet apart.</li> </ul>

### Fiber Rolls

- Place fiber rolls into a 2 to 4 inch trench.
- Stake or tie fiber rolls into place.
  - Tied fiber rolls staking is spaced at 2 feet apart.
  - Stake in the center of the fiber roll, spacing is at 2 feet apart.
- Use wood stakes with a nominal classification of 0.75 by 0.75 inch and minimum length of 24 inches.
- If more than one fiber roll is placed in a row, the rolls should be overlapped, not abutted.
- Drive stakes at the end of each fiber roll. If fiber rolls are overlapped, stake through both overlapped fiber rolls.
- Turn the ends of the fiber roll up slope to prevent runoff from going around the roll.

### Gravel Bag Berms

#### Gravel Bags

- Bags shall be woven polypropylene, polyethylene, or polyamide fabric.
- Minimum unit weight of 8 ounces per square yard.

Sources include EPA, SWRCB, Caltrans, CASQA  
**Temporary Sediment Control**



# Temporary Sediment Control

## TSC-5 Slope BMP: Fiber Roll or Gravel Bag Berm

- Burst strength exceeding 200 lbs in conformance with ASTM designation D4632.
- Ultraviolet stability exceeding 70% in conformance with ASTM designation D4355.
- Each gravel-filled bag shall have a length of 24-32 inches, width of 16-20 inches, and mass of approximately 30-50 lbs.
- Fill material shall be between 3/8 and 1 inch in diameter.
- Fill material shall be free from clay balls, organic matter, sand or silt, and other deleterious material.

### Installation Requirements

- Install along a level contour.
- Clear bedding area of obstructions one inch in diameter or larger.
- Place in single layer with ends abutted tightly and not overlapped.
- Turn ends of bags (last 6 feet) up slope to prevent flow around ends.
- Use in conjunction with temporary soil stabilization.
- When using at the toe of the slope, construct barriers with a set-back of at least 3 feet from toe of slope.

### Maintenance & Inspection

Inspect BMPs prior to forecast rain, daily during extended rain events, after rain events, and weekly throughout the life of the Project.

#### Fiber Rolls

- Repair or replace split, torn, unraveling, flattened, or slumping fiber rolls.
- Remove the sediment after it reaches 1/3 height of the fiber roll. Dispose of sediment in a proper place that will not allow contamination of the stormwater system.
- Properly dispose of the fiber roll if it has been damaged or is no longer needed and cannot be reused.

#### Gravel Bag Berms

- Gravel bags exposed to sunlight will need to be replaced every two to three months due to degradation of the bags.
- Reshape or replace gravel bags as needed.
- Repair washouts or other damage as needed. Split or torn gravel bags must be repaired, if possible, or replaced.
- Inspect gravel bag berms for sediment accumulation. Sediment that accumulates in the BMP must be periodically removed in order to maintain BMP effectiveness. Sediment should be removed when the sediment accumulation reaches one-third of the barrier height. Sediment removed during maintenance must be disposed of in a proper place that will not allow contamination of the stormwater system.
- Properly dispose of gravel bags that have been damaged or are no longer needed and cannot be reused.

Sources include EPA, SWRCB, Caltrans, CASQA  
**Temporary Sediment Control**



# Temporary Sediment Control

## TSC-5 Slope BMP: Fiber Roll or Gravel Bag Berm

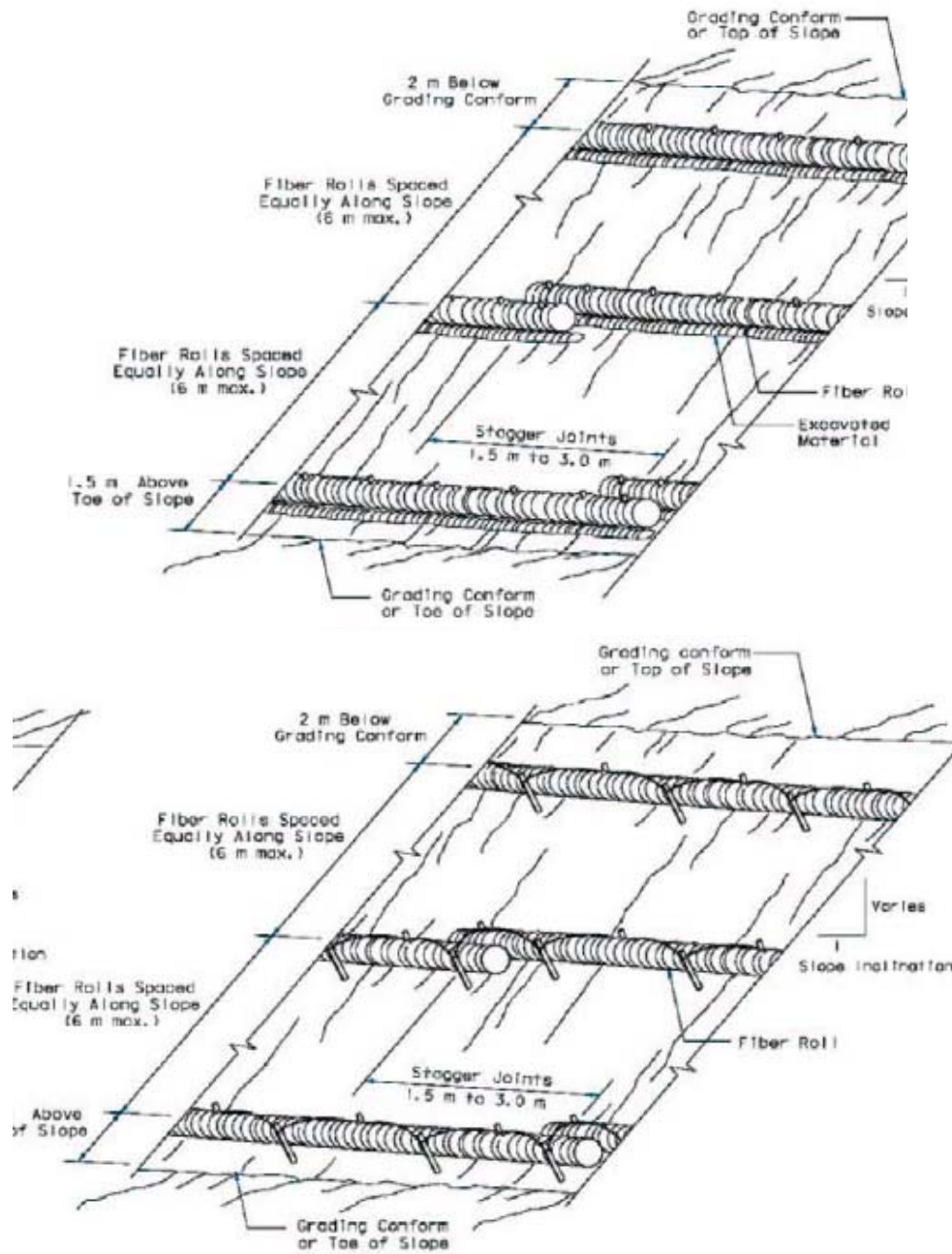

Sources include EPA, SWRCB, Caltrans, CASQA  
**Temporary Sediment Control**

## Tracking Control Introduction

Vehicles entering and leaving the construction site have the potential to track significant amounts of sediment onto roadways. Identify and clearly mark one or two locations where vehicles will enter and exit the construction site and focus stabilizing measures at these locations. Instruct employees, subcontractors, guests and anyone driving a vehicle on the site to only enter or exit the site at a stabilized entrance. All new and existing roadways, curbs, and gutters must be protected from sediment-laden runoff, are considered as perimeters of the site, and will need to be swept and vacuumed daily to ensure sediment and pollutants from construction activities are not leaving the site and potentially entering the stormdrain system. If construction parking is permitted on the Project site, then the area needs to be properly maintained and free of tracking and trash. The Contractor is required to implement, at a minimum, the following applicable measures, or equivalent BMPs with the approval of the University's Representative.

### **TC – 1 Stabilized Construction Entrance: Rumble Strips**

A stabilized entrance is defined by a point of entrance/exit to a construction site that is stabilized to reduce the tracking of mud and dirt onto public roadways by construction vehicles and activities.

### **TC – 2 Sweeping and Vacuuming**

Street sweeping and vacuuming includes the use of self-propelled equipment to remove sediment from all new and existing roadways, curbs, and gutters, and to clean paved surfaces in preparation for final paving.



# Tracking Control

## TC-1 Stabilized Construction Entrance: Rumble Strips

Definition	A stabilized entrance is defined by a point of entrance/exit to a construction site that is stabilized to reduce the tracking of mud and dirt onto public roadways by construction vehicles and activities.
Purpose	To prevent the tracking of mud, sediment, and pollutants from construction vehicles and activities on public roadways.
Conditions Where the Practice Applies	Stabilized construction entrances will be installed at all entrances and exits to the construction site including staging areas and Contractor parking.
Specifications: Design and Installation	<ul style="list-style-type: none"> <li>• Limit the points of entrance/exit to the construction site.</li> <li>• Stabilize all entrances/exits to the construction site before construction and further site disturbing activities begin.</li> <li>• Limit the speed of vehicles entering/exiting the site and travelling in the construction site to control dust.</li> <li>• Construct on level ground or properly grade each construction entrance/exit to prevent runoff from leaving the construction site.</li> <li>• The stabilized construction entrance/exit will be extended to a paved public roadway..</li> <li>• Rumble strips are metal panels with steel ridges or corrugations. Must be a minimum of 50 feet in length, and 15 feet minimum width, or longer and wider to accommodate anticipated traffic volume. Multiple rumble strips may be used to achieve the required dimensions. Place panels on a stable base.</li> <li>• Construct barriers around the sides of the rumble strips to ensure all tires of all construction vehicles and equipment travel over the rumble strips.</li> <li>• Design stabilized entrance/exit to support the heaviest vehicles and equipment that will use it.</li> <li>• Route runoff from stabilized entrances/exits through a sediment-trapping device before discharge.</li> <li>• Require all employees, subcontractors, guests, and suppliers to utilize the stabilized construction access.</li> <li>• No vehicle or equipment is to access the construction site by any means other than the stabilized entrance/exit unless approved by the University's Representative, the area properly cleaned after use, and the event documented.</li> <li>• Implement TC – 2 Sweeping and Vacuuming on a regular basis as specified.</li> </ul>
Maintenance & Inspection	<ul style="list-style-type: none"> <li>• Inspect BMPs prior to forecast rain, daily during extended rain events, after rain events, and weekly throughout the life of the Project.</li> <li>• Inspect routinely for damage and assess effectiveness of the BMP. Remove</li> </ul>

Sources include EPA, SWRCB, Caltrans, CASQA

**Tracking Control**





# Tracking Control

## TC-1 Stabilized Construction Entrance: Rumble Strips

aggregate, sediment, and other contaminants from the BMP to ensure functioning properly. Do not use water to clean unless approved by the University's Representative. Wash water is not to leave the construction site.

- Inspect local roadways, curb, and gutter adjacent to the site daily. Sweep daily to remove accumulated sediment.
- Keep all new and existing roadways, curbs, and gutters free of sediment and other contaminants from construction activities. Remove all sediment deposited on paved roadways by the end of the work day.
- Inspect for damage and needed repairs.



# Tracking Control

## TC-2 Sweeping and Vacuuming

Definition	Street sweeping and vacuuming includes the use of self-propelled equipment to remove sediment from all new and existing roadways, curbs, and gutters, and to clean paved surfaces in preparation for final paving.
Purpose	Sweeping and vacuuming prevents sediment from the Project site from entering stormdrains or receiving waters.
Conditions Where the Practice Applies	Sweeping and vacuuming are suitable anywhere sediment is tracked from the Project site onto public or private paved streets and roads, typically at points of egress. Sweeping and vacuuming are also applicable during preparation of paved surfaces for final paving.
Specifications: Design and Installation	<ul style="list-style-type: none"> <li>• Controlling the number of points where vehicles can leave the site will allow sweeping and vacuuming efforts to be focused, and perhaps save money.</li> <li>• Inspect potential sediment tracking locations daily, including all new and existing roadways, construction parking, curbs, and gutters.</li> <li>• Visible sediment tracking should be swept or vacuumed on a daily basis.</li> <li>• Do not use kick brooms or sweeper attachments. These tend to spread the dirt rather than remove it.</li> <li>• Dispose of the collected sediment, debris, and trash properly.</li> </ul>
Maintenance & Inspection	<ul style="list-style-type: none"> <li>• Inspect BMPs prior to forecast rain, daily during extended rain events, after rain events, and weekly throughout the life of the Project.</li> <li>• Points of ingress and egress must be inspected daily.</li> <li>• When tracked or spilled sediment is observed outside the construction perimeter, it must be removed at least daily.</li> <li>• Be careful not to sweep up any unknown substance or any object that may be potentially hazardous.</li> <li>• Adjust brooms frequently; maximize efficiency of sweeping operations.</li> <li>• After sweeping is finished, properly dispose of sweeper wastes at an approved dumpsite.</li> </ul>

## Wind Erosion Control Introduction

Disturbed and exposed areas are increasingly subject to wind erosion, sediment tracking, and dust generated by construction equipment because soils dry out during California's long hot dry season. Wind erosion control consists of applying water and/or other dust palliatives as necessary to prevent or alleviate erosion by the forces of wind. Contractor shall use best available dust suppression equipment and methods to control dust so that the dust does not cause discomfort or nuisance to occupants of the Project site neighboring property. Contractor shall control dust suppression water so that it is effective in controlling dust, but does not leave the Project site or enter the stormdrain system. Contractor shall describe their dust suppression water management methods in the Questionnaire/SWPPP. The Contractor is required to implement, at a minimum, the following measure, or equivalent BMPs with the approval of the University's Representative.

### WEC – 1 Dust Control

Dust control is a practice used to reduce the air transport of dust during construction activities by stabilizing exposed surfaces and minimizing activities that suspend or track dust particles.



# Wind Erosion Control

## WEC-1 Dust Control

Definition	Dust control is a practice used to reduce the air transport of dust during construction activities by stabilizing exposed surfaces and minimizing activities that suspend or track dust particles.
Purpose	Control dust so dust does not infiltrate into stormwater and does not cause discomfort or nuisance to occupants of the Project site or neighboring properties.
Conditions Where the Practice Applies	<p>Wind erosion control BMPs should be applied to all construction earth disturbing activities, including the following construction activities:</p> <ul style="list-style-type: none"> <li>• Construction vehicle traffic on unpaved surfaces.</li> <li>• Drilling and blasting activities.</li> <li>• Sediment tracking onto paved roads.</li> <li>• Soils and debris storage piles.</li> <li>• Batch drop from front-end loaders.</li> <li>• Areas with unstabilized soil.</li> <li>• Final grading/site stabilization.</li> </ul>
Specifications: Design and Installation	<p><u>Preventive Measures:</u></p> <ul style="list-style-type: none"> <li>• Schedule construction activities to minimize exposed area.</li> <li>• Quickly stabilize exposed soils.</li> <li>• Identify and stabilize key access points prior to construction.</li> <li>• Minimize the impact of dust by anticipating the direction of prevailing winds.</li> <li>• Direct most construction traffic to stabilized roadways within the Project site.</li> <li>• Water should be applied by means of pressure-type distributors or pipelines equipped with a spray system or hoses and nozzles that will ensure even distribution.</li> <li>• All distribution equipment should be equipped with a positive means of shutoff.</li> <li>• Unless water is applied by means of pipelines, at least one mobile unit should be available at all times to apply water or dust palliative to the Project.</li> <li>• Pave or chemically stabilize access points where unpaved traffic surfaces adjoin paved roads.</li> <li>• Provide covers for haul trucks transporting materials that contribute to dust.</li> <li>• Provide for wet suppression or chemical stabilization of exposed soils.</li> <li>• Provide for rapid clean up of sediments deposited on paved roads. Furnish stabilized construction road entrances.</li> <li>• Stabilize inactive construction sites using BMPs such as vegetation.</li> <li>• Limit the amount of areas disturbed by clearing and earth moving operations by scheduling these activities in phases.</li> <li>• Cover stockpiles with plastics and make sure they are secure.</li> </ul>

Sources include EPA, SWRCB, Caltrans, CASQA

**Wind Erosion Control**



# Wind Erosion Control

## WEC-1 Dust Control

### Maintenance & Inspection

- Inspect BMPs prior to forecast rain, daily during extended rain events, after rain events, and weekly throughout the life of the Project.
- Inspect and verify that activity-based BMPs are in place prior to the commencement of associated activities.
- Check areas protected to ensure coverage.
- Most dust control measures require frequent, often daily, or multiple times per day attention.

## Non-Stormwater Management Introduction

Non-stormwater discharges may contribute a significant pollutant load to receiving waters. The General Permit prohibits the discharge of materials other than clean stormwater and authorized non-stormwater discharges to the stormdrain system. Eliminate all unauthorized non-stormwater discharges to the extent feasible. Assign a qualified person the responsibility for ensuring that no materials other than stormwater, free of all contaminants, are discharged. Include the name, contact information, and qualifications of said person in the Questionnaire/SWPPP. Non-stormwater discharges include a wide variety of sources, including improper dumping, spills, or leakage from storage tanks or transfer areas. The Contractor is required to implement, at a minimum, the following applicable measures, or equivalent BMPs with the approval of the University's Representative.

### **NSM – 1 Water Conservation**

Water conservation practices are activities that use water during the construction of a Project in a manner that avoids causing erosion and the transport of pollutants offsite. These practices can reduce or eliminate non-stormwater discharges.

### **NSM – 2 Dewatering Operations**

Dewatering operations are practices that manage the discharge of pollutants when non-stormwater and accumulated precipitation must be removed from a work location so that construction work may be accomplished.

### **NSM – 3 Vehicle and Equipment Practices**

Vehicle and equipment practices are used to minimize or eliminate the discharge of pollutants from vehicle and equipment washing, fueling, and maintenance to stormdrain system or from leaving the Project site perimeter. The best way to prevent stormwater contamination from vehicle and equipment operations is to perform washing, fueling, and maintenance at an offsite facility.

### **NSM – 4 Illicit Connection/Illegal Discharge Detection**

Procedures and practices designed for construction Contractors to recognize illicit connections or illegally dumped or discharged materials on a construction site and report incidents. Illicit connections and illegal discharges can be in solid or liquid form.

### **NSM – 5 Concrete Curing**

Concrete curing is used in the construction of structures such as bridges, retaining walls, pump houses, large slabs, and structured foundations. Concrete curing includes the use of both chemical and water methods.

### **NSM – 6 Concrete Finishing**

Concrete finishing methods are used for bridge deck rehabilitation, paint removal, curing compound removal, and final surface finish appearances. Methods include sand blasting, grinding, or high pressure water blasting. Stormwater and non-stormwater exposed to concrete finishing by-products may have high pH and may contain chemicals, metals, and fines.

**NSM – 7 Paving and Grinding**

Procedures and practices for conducting paving, saw cutting, and grinding operations to minimize the transport of pollutants to the stormdrain system and to the site perimeter.

**NSM – 8 Potable Water/Irrigation**

Potable water/irrigation management consists of practices and procedures to manage the discharge of potential pollutants generated during discharges from irrigation water lines, landscape irrigation, lawn or garden watering, planned and unplanned discharges from potable water sources, water line flushing, and hydrant flushing.

**NSM – 9 Material Use**

Use alternative products, minimize hazardous material use onsite, and train employees and subcontractors to prevent or reduce the discharge of pollutants to the stormdrain system or watercourses from material use.



# Non-Stormwater Management

## NSM-1 Water Conservation

Definition	Water conservation practices are activities that use water during the construction of a Project in a manner that avoids causing erosion and the transport of pollutants offsite. These practices can reduce or eliminate non-stormwater discharges.
Purpose	Avoid causing erosion and the transport of pollutants offsite.
Conditions Where the Practice Applies	Water conservation practices are suitable for all construction sites where water is used, including piped water, metered water, trucked water, and water from a reservoir.
Specifications: Design and Installation	<ul style="list-style-type: none"> <li>• University's Representative must approve all washing activities if there is a potential to discharge to the stormdrain system or for discharge to leave the Project site.</li> <li>• Do not wash paved areas.</li> <li>• Keep water equipment in good working condition.</li> <li>• Stabilize water truck filling area.</li> <li>• Repair water leaks promptly.</li> <li>• Washing of vehicles and equipment on the construction site is discouraged.</li> <li>• Avoid using water to clean construction areas. If water must be used for cleaning or surface preparation, surface should be swept and vacuumed first to remove dirt. This will minimize amount of water required.</li> <li>• Direct construction water runoff to areas where it can soak into the ground or be collected and reused.</li> <li>• Authorized non-stormwater discharges to the stormdrain system are acceptable with the implementation of appropriate BMPs. Verify with the University's Representative before discharging non-stormwater to the stormdrain system or off the Project site.</li> <li>• Lock water valves to prevent unauthorized use.</li> <li>• Inspect irrigation systems and adjust watering schedules.</li> <li>• Shut off water sources to broken lines, sprinklers, or valves.</li> <li>• Reuse water line flushing for landscape irrigation.</li> <li>• Route water from water line repair to landscape areas for infiltration.</li> <li>• Prevent water truck filling areas from discharging.</li> </ul>
Maintenance & Inspection	<ul style="list-style-type: none"> <li>• Inspect BMPs prior to forecast rain, daily during extended rain events, after rain events, and weekly throughout the life of the Project.</li> <li>• Inspect and verify that activity based BMPs are in place prior to the commencement of authorized non-stormwater discharges.</li> <li>• Repair water equipment as needed to prevent unintended discharges, including: water trucks, water reservoirs, irrigation systems, and hydrant connections.</li> </ul>

Sources include EPA, SWRCB, Caltrans, CASQA  
**Non-Stormwater Management**





# Non-Stormwater Management

## NSM-2 Dewatering Operations

Definition	Dewatering operations are practices that manage the discharge of pollutants when non-stormwater and accumulated precipitation must be removed from a work location so that construction work may be accomplished.
Purpose	To remove non-stormwater and accumulated precipitation from the construction site in such a way so as to not pollute the stormdrain system.
Conditions Where the Practice Applies	<p>These practices are implemented for discharges of non-stormwater from construction sites. Non-stormwaters include, but are not limited to, groundwater, water from cofferdams, water diversions, and waters used during construction activities that must be removed from a work area.</p> <p>Practices identified in this section are also appropriate for implementation when managing the removal of accumulated precipitation (stormwater) from depressed areas at a construction site.</p>
Specifications: Design and Installation	<ul style="list-style-type: none"> <li>• Site conditions will dictate design and use of dewatering operations.</li> <li>• The controls discussed in this BMP address sediment only.</li> <li>• Dewatering operations will require, and must comply with, applicable local permits.</li> <li>• Avoid dewatering discharges where possible by using water for dust control, by infiltration, etc.</li> <li>• Unauthorized non-stormwater cannot be discharged without obtaining a permit from the Central Coast Regional Waster Quality Control Board. This includes stormwater that is co-mingled with groundwater or other non-stormwater sources. Once the discharge is allowed, appropriate BMPs must be implemented to ensure the discharge complies with all permit requirements and regional and watershed specific requirements.</li> <li>• The permit required by the Central Coast RWQCB has specific testing, monitoring, and discharge requirements and can take significant time to obtain.</li> <li>• The flowchart shown in Figure 1 should be utilized to guide dewatering operations.</li> <li>• The Contractor will coordinate monitoring and dewatering permit compliance.</li> <li>• Dewatering operations must not cause erosion at the discharge point.</li> </ul>

### Dewatering Methods

A variety of methods can be used to treat water during dewatering operations. Several devices are presented below and provide options to achieve sediment removal. The size of particles present in the sediment and Permit or receiving water limitations on sediment are key considerations for selecting sediment treatment option(s); in some cases, the use of multiple devices may be appropriate.

Sources include EPA, SWRCB, Caltrans, CASQA  
**Non-Stormwater Management**



# Non-Stormwater Management

## NSM-2 Dewatering Operations

### **Weir Tanks**

#### *Description:*

- A weir tank separates water and waste by using weirs. The configuration of the weirs (over and under weirs) maximizes the residence time in the tank and determines the waste to be removed from the water, such as oil, grease, and sediments.

#### *Appropriate Applications:*

- The tank removes trash, some settleable solids (gravel, sand, silt), some visible oil and grease, and some metals (removed with sediment). To achieve high levels of flow, multiple tanks can be used in parallel. If additional treatment is desired, the tanks can be placed in series or as pre-treatment for other methods.

#### *Implementation:*

- Tanks are delivered to the site by the vendor, who can provide assistance with set-up and operation.
- Tank size will depend on flow volume, constituents of concern, and residency period required. Vendors should be consulted to appropriately size the tank.

#### *Maintenance:*

- Periodic cleaning is required based on visual inspection or reduced flow.
- Oil and grease disposal must be by licensed waste disposal company.

### **Dewatering Tanks**

#### *Description:*

- A dewatering tank removes debris and sediment. Flow enters the tank through the top, passes through a fabric filter, and is discharged through the bottom of the tank. The filter separates the solids from the liquids.

#### *Appropriate Applications:*

- The tank removes trash, gravel, sand, and silt, some visible oil and grease, and some metals (removed with sediment). To achieve high levels of flow, multiple tanks can be used in parallel. If additional treatment is desired, the tanks can be placed in series or as pretreatment for other methods.

#### *Implementation:*

- Tanks are delivered to the site by the vendor, who can provide assistance with set-up and operation.
- Tank size will depend on flow volume, constituents of concern, and residency period required. Vendors should be consulted to appropriately size tank.

#### *Maintenance:*

- Periodic cleaning is required based on visual inspection or reduced flow.
- Oil and grease disposal must be by licensed waste disposal company.
- Inspect BMPs prior to forecast rain, daily during extended rain events, after rain events, and weekly throughout the life of the Project.
- Perform maintenance as described for each dewatering method.

Maintenance &  
Inspection

Sources include EPA, SWRCB, Caltrans, CASQA  
**Non-Stormwater Management**



# Non-Stormwater Management

## NSM-2 Dewatering Operations

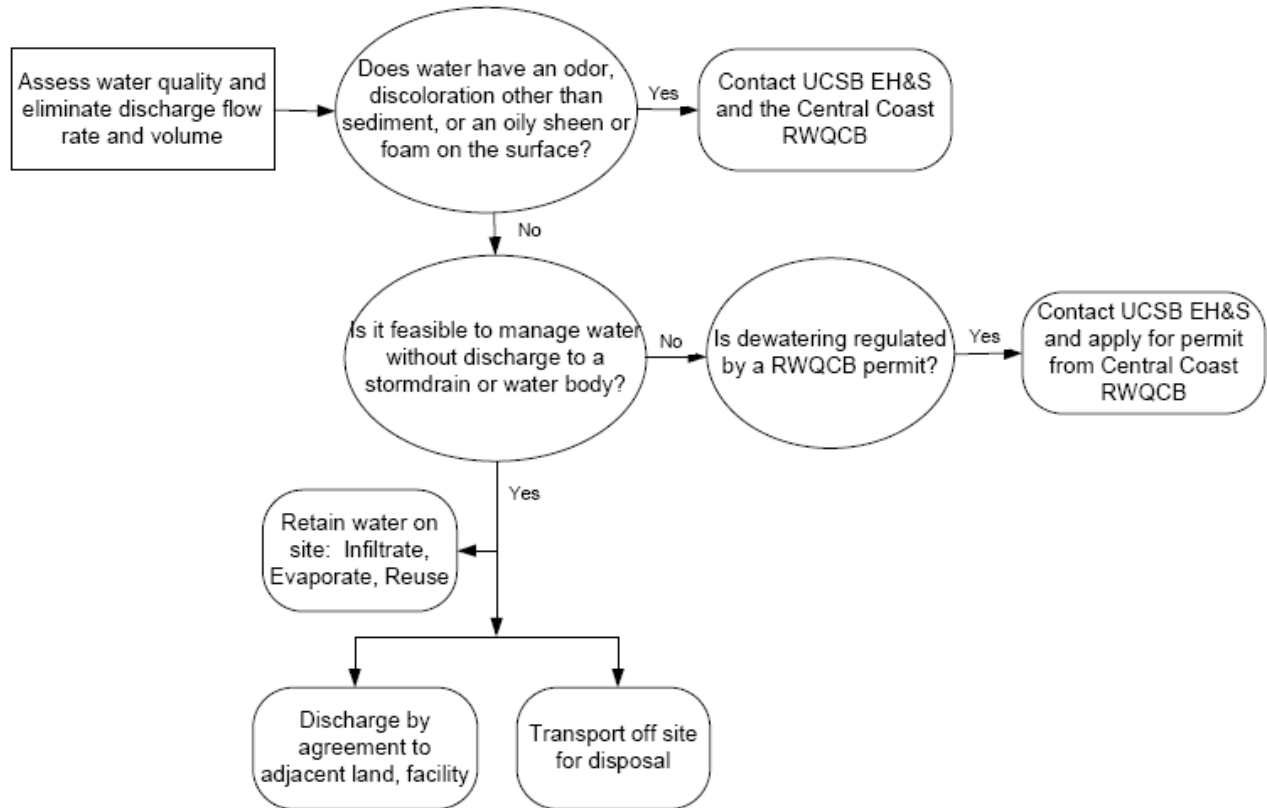

Figure 1 Dewatering Flowchart



# Non-Stormwater Management

## NSM-3 Vehicle and Equipment Practices

Definition	Vehicle and equipment practices are used to minimize or eliminate the discharge of pollutants from vehicle and equipment washing, fueling, and maintenance to stormdrain system or from leaving the Project site perimeter. The best way to prevent stormwater contamination from vehicle and equipment operations is to perform washing, fueling, and maintenance at an offsite facility.
Purpose	Prevent discharges from wash water, fuel from spills and leaks, and to reduce or eliminate contamination of stormwater.
Conditions Where the Practice Applies	These procedures are suitable on all construction sites where vehicles and equipment operations are performed.
Specifications: Design and Installation	<p><u>Vehicle and Equipment Cleaning</u></p> <p>Send vehicles/equipment offsite to be cleaned at a commercial washing business whenever possible. All vehicles and equipment that regularly enter and leave the construction site must be cleaned offsite.</p> <p>If vehicle/equipment must occur onsite do the following:</p> <ul style="list-style-type: none"> <li>• Use phosphate-free, biodegradable soaps.</li> <li>• Educate employees and subcontractors on pollution prevention measures.</li> <li>• Do not permit steam cleaning onsite. Steam cleaning can generate pollutant concentrates.</li> <li>• Cleaning of vehicles and equipment with soap, solvents or steam should not occur on the Project site unless approved by the University's Representative and the resulting wastes are fully contained and disposed of. Resulting wastes should not be discharged or buried, and must be captured and recycled or disposed in an appropriate manner. Minimize use of solvents. Use of diesel for vehicle and equipment cleaning is prohibited.</li> <li>• When vehicle and equipment washing and cleaning must occur onsite, and the operation cannot be located within a structure or building equipped with appropriate disposal facilities, the outside cleaning area should have the following characteristics:             <ul style="list-style-type: none"> <li>• Located away from stormdrain inlets, drainage facilities, watercourses, Project site perimeter.</li> <li>• Paved with concrete or asphalt and bermed to contain wash waters and to prevent runoff and runoff.</li> <li>• Configured with a sump to allow collection and disposal of wash water.</li> <li>• No discharge of wash waters to stormdrains or watercourses.</li> </ul> </li> </ul>

Sources include EPA, SWRCB, Caltrans, CASQA  
**Non-Stormwater Management**



# Non-Stormwater Management

## NSM-3 Vehicle and Equipment Practices

- Used only when necessary.
- Use as little water as possible. High pressure sprayers may use less water than a hose and should be considered.
- Use positive shutoff valve to minimize water usage.

### Vehicle and Equipment Fueling

Use offsite fueling stations as much as possible. These businesses are better equipped to handle fuel and spills properly. Performing this work offsite can also be economical by eliminating the need for a separate fueling area on the Project site.

If fuelling must occur onsite, do the following:

- Discourage “topping-off” of fuel tanks.
- Absorbent spill cleanup materials and spill kits should be available in fueling areas and on fueling trucks, and should be disposed of properly after use.
- Drip pans or absorbent pads should be used during vehicle and equipment fueling, unless the fueling is performed over an impermeable surface in a dedicated fueling area.
- Use absorbent materials on small spills. Do not hose down or bury the spill. Remove the adsorbent materials promptly and dispose of properly.
- Avoid mobile fueling of mobile construction equipment around the site; rather, transport the equipment to designated fueling areas. With the exception of tracked equipment such as bulldozers and large excavators, most vehicles should be able to travel to a designated area with little lost time.
- Train employees and subcontractors in proper fueling and cleanup procedures.
- When fueling must take place onsite, designate an area away from drainage courses to be used. Fueling areas should be identified in the Questionnaire/SWPPP and on the BMP Site Map.
- Dedicated fueling areas should be protected from stormwater runoff and runoff, and should be located at least 50 feet away from downstream drainage facilities, watercourses, stormdrain inlets, and the Project site perimeter. Fueling must be performed on level-grade areas.
- Protect fueling areas with berms and dikes to prevent runoff, and to contain spills.
- Nozzles used in vehicle and equipment fueling should be equipped with an automatic shutoff to control drips. Fueling operations should not be left unattended.
- Use vapor recovery nozzles to help control drips as well as air pollution, must be in compliance with the California Air Resources Board and the Santa Barbara County Air Pollution Control District regulations.

Sources include EPA, SWRCB, Caltrans, CASQA  
**Non-Stormwater Management**



# Non-Stormwater Management

## NSM-3 Vehicle and Equipment Practices

- Contractor is required to be in compliance with all federal, state, and local requirements in regards to any and all off-road diesel equipment, portable engines, and stationary above ground storage tanks.

### Vehicle and Equipment Maintenance

Use offsite repair shops as much as possible. These businesses are better equipped to handle vehicle fluids and spills properly. Performing this work offsite can also be economical by eliminating the need for a separate maintenance area.

If maintenance must occur onsite, do the following:

- Use designated areas, located away from drainage courses, stormdrain inlets, and the Project site perimeter. Dedicated maintenance areas should be protected from stormwater runoff and runoff, and should be located at least 50 feet away from downstream drainage facilities, watercourses, stormdrain inlets, and the Project site perimeter.
- Drip pans or absorbent pads should be used during vehicle and equipment maintenance work that involves fluids, unless the maintenance work is performed over an impermeable surface in a dedicated maintenance area.
- Place a stockpile of spill cleanup materials where it will be readily accessible.
- All fueling trucks and fueling areas are required to have spill kits and/or use other spill protection devices.
- Use adsorbent materials on small spills. Remove the absorbent materials promptly and dispose of properly.
- Inspect onsite vehicles and equipment daily at startup for leaks, and repair immediately.
- Keep vehicles and equipment clean; do not allow excessive build-up of oil and grease.
- Segregate and recycle wastes, such as greases, used oil or oil filters, antifreeze, cleaning solutions, automotive batteries, hydraulic fluids, and transmission fluids. Provide secondary containment and covers for these materials if stored onsite.
- Train employees and subcontractors in proper maintenance and spill cleanup procedures.
- Consider using portable tents or covers over maintenance areas if maintenance cannot be performed offsite.
- Consider use of new, alternative greases and lubricants, such as adhesive greases, for chassis lubrication and fifth-wheel lubrication.
- Properly dispose of used oils, fluids, lubricants, and spill cleanup materials.
- Do not place used oil in a dumpster or pour into a stormdrain, watercourse, or anywhere except a proper disposal container.

Sources include EPA, SWRCB, Caltrans, CASQA  
**Non-Stormwater Management**



# Non-Stormwater Management

## NSM-3 Vehicle and Equipment Practices

- Properly dispose of or recycle used batteries.
- Do not bury used tires.
- Repair leaks of fluids and oil immediately.

### Safer Alternative Products

- Consider products that are less toxic or hazardous than regular products. These products are often sold under an “environmentally friendly” label.
- Consider use of grease substitutes for lubrication of truck fifth-wheels. Follow manufacturers label for details on specific uses.
- Consider use of plastic friction plates on truck fifth-wheels in lieu of grease. Follow manufacturers label for details on specific uses.

### Waste Reduction

Parts are often cleaned using solvents such as trichloroethylene, trichloroethane, or methylene chloride. Many of these cleaners are listed in California Toxic Rule as priority pollutants. These materials are harmful and must not contaminate stormwater. They must be disposed of as a hazardous waste. Reducing the number of solvents makes recycling easier and reduces hazardous waste management costs. Often, one solvent can perform a job as well as two different solvents. Also, if possible, eliminate or reduce the amount of hazardous materials and waste by substituting non-hazardous or less hazardous materials. For example, replace chlorinated organic solvents with non-chlorinated solvents. Also, try substituting a wire brush for solvents to clean parts.

### Recycling and Disposal

Separating wastes allows for easier recycling and may reduce disposal costs. Keep hazardous wastes separate, do not mix used oil solvents, and keep chlorinated solvents (like trichloroethane) separate from non-chlorinated solvents (like kerosene and mineral spirits). Promptly transfer used fluids to the proper waste or recycling drums. Don't leave full drip pans or other open containers lying around. Provide cover and secondary containment until these materials can be removed from the site.

- Oil filters can be recycled. Ask your oil supplier or recycler about recycling oil filters.
- Do not dispose of extra paints and coatings by dumping liquid onto the ground or throwing it into dumpsters. Allow coatings to dry or harden before disposal into covered dumpsters.
- Store cracked batteries in a non-leaking secondary container. Do this with all cracked batteries, even if you think all the acid has drained out. If you drop a battery, treat it as if it is cracked. Put it into the containment area until you are sure it is not leaking.

Sources include EPA, SWRCB, Caltrans, CASQA  
**Non-Stormwater Management**



# Non-Stormwater Management

## NSM-3 Vehicle and Equipment Practices

### Maintenance & Inspection

Inspect BMPs prior to forecast rain, daily during extended rain events, after rain events, and weekly throughout the life of the Project.

#### Vehicle and Equipment Cleaning

- Inspect BMPs subject to non-stormwater discharges daily while non-stormwater discharges occur.
- Inspection and maintenance is minimal, although some berm repair may be necessary.
- Monitor employees and subcontractors throughout the duration of the Project to ensure appropriate practices are being implemented.
- If a sump is used, inspect regularly and remove liquids and sediment as needed.
- Prohibit employees and subcontractors from washing personal vehicles and equipment on the construction site.

#### Vehicle and Equipment Fueling

- Vehicles and equipment should be inspected each day of use for leaks. Leaks should be repaired immediately or problem vehicles and equipment should be removed from the Project site.
- Keep ample supplies of spill cleanup materials onsite.
- Immediately clean up spills and properly dispose of contaminated soil and cleanup materials.

#### Vehicle and Equipment Maintenance

- Inspect BMPs subject to non-stormwater discharges daily while non-stormwater discharges occur.
- Keep ample supplies of spill cleanup materials onsite.
- Maintain waste fluid containers in leak proof condition.
- Vehicles and equipment should be inspected each day of use for leaks. Leaks should be repaired immediately or problem vehicles and equipment should be removed from the Project site.
- Inspect equipment for damaged hoses and leaky gaskets routinely. Repair or replace as needed.



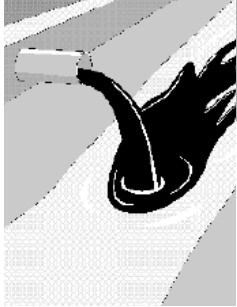

# Non-Stormwater Management

## NSM-4 Illicit Connection/Illegal Discharge Detection

Definition	Procedures and practices designed for construction Contractors to recognize illicit connections or illegally dumped or discharged materials on a construction site and report incidents. Illicit connections and illegal discharges can be in solid or liquid form.
Purpose	To prevent illicit connections and discharges to prevent contamination of stormwater and the UCSB watershed.
Conditions Where the Practice Applies	This BMP applies to all construction Projects. Illicit connection/discharge and reporting is applicable anytime an illicit connection or discharge is discovered or illegally dumped material is found on the construction site.
Specifications: Design and Installation	<p><u>Planning</u></p> <p>Review the Questionnaire/SWPPP. Pre-existing areas of contamination should be identified and documented in the Questionnaire/SWPPP and on the BMP Site Map.</p> <ul style="list-style-type: none"> <li>• Inspect the site before beginning the job for evidence of illicit connections, illegal dumping, or discharges. Document any pre-existing conditions and notify the University's Representative.</li> <li>• Inspect the site regularly during Project execution for evidence of illicit connections, illegal dumping, or discharges.</li> <li>• Observe the site perimeter for evidence for potential of illicitly discharged or illegally dumped material, which may enter the job site.</li> </ul> <p><u>Identification of Illicit Connections and Illegal Dumping or Discharges</u></p> <ul style="list-style-type: none"> <li>• General – Unlabeled and unidentifiable material should be treated as hazardous.</li> <li>• Solids – Look for debris or rubbish piles. Solid waste dumping often occurs on roadways with light traffic loads or in areas not easily visible from the traveled way.</li> <li>• Liquids – Signs of illegal liquid dumping or discharge can include:             <ul style="list-style-type: none"> <li>• Visible signs of staining or unusual colors to the pavement or surrounding adjacent soils.</li> <li>• Pungent odors coming from the drainage systems.</li> <li>• Discoloration or oily substances in the water or stains and residues detained within ditches, channels, or drain boxes.</li> <li>• Abnormal water flow during the dry weather season.</li> </ul> </li> <li>• Urban Areas – Evidence of illicit connections or illegal discharges is typically detected at stormdrain outfall locations or at manholes. Signs of an illicit connection or illegal discharge can include:</li> </ul>

Sources include EPA, SWRCB, Caltrans, CASQA  
**Non-Stormwater Management**

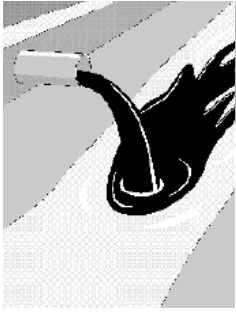

# Non-Stormwater Management

## NSM-4 Illicit Connection/Illegal Discharge Detection

- Abnormal water flow during the dry weather season.
- Unusual flows in sub drain systems used for dewatering.
- Pungent odors coming from the drainage systems.
- Discoloration or oily substances in the water or stains and residues detained within ditches, channels, or drain boxes.
- Excessive sediment deposits, particularly adjacent to or near active offsite construction Projects.
- Rural Areas – Illicit connections or illegal discharges involving irrigation drainage ditches are detected by visual inspections. Signs of an illicit discharge can include:
  - Abnormal water flow during the non-irrigation season.
  - Non-standard junction structures.
  - Broken concrete or other disturbances at or near junction structures.

### Reporting

Notify the University's Representative of any illicit connections and illegal dumping or discharge incidents at the time of discovery. For illicit connections or discharges to the stormdrain system, notify the University's Representative. For illegal dumping, notify the University's Representative and the UCSB Environmental Health & Safety department.

### Cleanup and Removal

The responsibility for cleanup and removal of illicit or illegal dumping or discharges will be the responsibility of the Contractor. Discuss with the University's Representative the best way to handle cleanup and removal.

### Maintenance & Inspection

- Inspect BMPs prior to forecast rain, daily during extended rain events, after rain events, and weekly throughout the life of the Project.
- Inspect the site regularly to check for any illegal dumping or discharge.
- Prohibit employees and subcontractors from disposing of non-job related debris or materials at the construction site.
- Notify the University's Representative of any illicit connections and illegal dumping or discharge incidents at the time of discovery.



# Non-Stormwater Management

## NSM-5 Concrete Curing

Definition	Concrete curing is used in the construction of structures such as bridges, retaining walls, pump houses, large slabs, and structured foundations. Concrete curing includes the use of both chemical and water methods.
Purpose	Discharges of stormwater and non-stormwater exposed to concrete during curing may have a high pH and may contain chemicals, metals, and fines. Proper procedures reduce or eliminate the contamination of stormwater runoff during concrete curing.
Conditions Where the Practice Applies	All concrete elements of a structure (e.g., footings, columns, abutments, stems, soffit, and deck) are subject to curing requirements. Suitable applications include all Projects where Portland Cement Concrete (PCC) and concrete curing chemicals are placed where they can be exposed to rainfall, runoff from other areas, or where runoff from the PCC will leave the site and/or enter the stormdrain system.
Specifications: Design and Installation	<p><u>Chemical Curing</u></p> <ul style="list-style-type: none"> <li>• Avoid over spray of curing compounds.</li> <li>• Minimize the drift of chemical cure as much as possible by applying the curing compound close to the concrete surface. Apply an amount of compound that covers the surface, but does not allow any runoff of the compound.</li> <li>• Protect drain inlets prior to the application of curing compounds.</li> </ul> <p><u>Water Curing for Bridge Decks, Retaining Walls, and other Structures</u></p> <ul style="list-style-type: none"> <li>• Direct cure water away from inlets and watercourses to collection areas for infiltration or other means of removal in accordance with all applicable permits.</li> <li>• Collect cure water at the top of slopes and transport or dispose of water in a non-erodible manner that does not pollute stormwater.</li> <li>• Utilize wet blankets or similar method that maintains moisture while minimizing the use and possibly discharge of water.</li> </ul>
Maintenance & Inspection	<ul style="list-style-type: none"> <li>• Inspect BMPs prior to forecast rain, daily during extended rain events, after rain events, and weekly throughout the life of the Project.</li> <li>• Inspect BMPs subject to non-stormwater discharges daily while non-stormwater discharges occur.</li> <li>• Ensure that employees and subcontractors implement appropriate measures for storage, handling, and use of curing compounds.</li> <li>• Inspect cure containers and spraying equipment for leaks.</li> </ul>



# Non-Stormwater Management

## NSM-6 Concrete Finishing

Definition	Concrete finishing methods are used for bridge deck rehabilitation, paint removal, curing compound removal, and final surface finish appearances. Methods include sand blasting, grinding, or high pressure water blasting. Stormwater and non-stormwater exposed to concrete finishing by-products may have high pH and may contain chemicals, metals, and fines.
Purpose	Proper procedures and implementation of appropriate BMPs can minimize the impact that concrete finishing methods may have on stormwater and non-stormwater discharges.
Conditions Where the Practice Applies	These procedures apply to all construction locations where concrete finishing operations are performed.
Specifications: Design and Installation	<ul style="list-style-type: none"> <li>• Collect and properly dispose of water from high-pressure water blasting operations.</li> <li>• Collect contaminated water from blasting operations at the top of slopes. Transport or dispose of contaminated water while using BMPs such as those for erosion control.</li> <li>• Direct water from blasting operations away from inlets and watercourses to collection areas for infiltration or other means of removal.</li> <li>• Protect inlets during sandblasting operations.</li> <li>• Refer to WM – 3 Temporary Concrete Washout and Waste Management for disposal of concrete based debris.</li> <li>• Minimize the drift of dust and blast material as much as possible by keeping the blasting nozzle close to the surface.</li> <li>• When blast residue contains a potentially hazardous waste, refer to the WM – 7 Hazardous Waste Management.</li> </ul>
Maintenance & Inspection	<ul style="list-style-type: none"> <li>• Inspect BMPs prior to forecast rain, daily during extended rain events, after rain events, and weekly throughout the life of the Project.</li> <li>• Inspect BMPs subject to non-stormwater discharges daily while non-stormwater discharges occur.</li> <li>• Sweep or vacuum up debris from sandblasting at the end of each shift.</li> <li>• At the end of each work shift, remove and contain liquid and solid waste from containment structures, if any, and from the general work area.</li> </ul>

Sources include EPA, SWRCB, Caltrans, CASQA  
**Non-Stormwater Management**



# Non-Stormwater Management

## NSM-7 Paving and Grinding

Definition	Procedures and practices for conducting paving, saw cutting, and grinding operations to minimize the transport of pollutants to the stormdrain system and to the Project site perimeter.
Purpose	Prevent the discharge of pollutants from paving operations, using measures to prevent runoff and runoff pollution, properly disposing of wastes, and training employees and subcontractors.
Conditions Where the Practice Applies	These procedures are implemented where paving, surfacing, resurfacing, grinding, or saw cutting, may pollute stormwater runoff or discharge to the stormdrain system or watercourses.
Specifications: Design and Installation	<p><u>General</u></p> <ul style="list-style-type: none"> <li>• Avoid paving during the wet season when feasible.</li> <li>• Reschedule paving and grinding activities if rain is in the forecast.</li> <li>• Train employees and subcontractors in pollution prevention and reduction.</li> <li>• Store materials away from stormdrains and drainage courses to prevent stormwater runoff, see WM – 1 Material Delivery and Storage.</li> <li>• Protect drainage courses, particularly in areas with a grade, by employing BMPs to divert runoff or to trap and filter sediment.</li> <li>• If paving involves an onsite mixing plant, follow the stormwater permitting requirements for industrial activities.</li> <li>• Stockpile material removed from roadways away from drain inlets, drainage ditches, and watercourses. These materials should be stored consistent with WM – 5 Stockpile Management.</li> <li>• Disposal of PCC and AC waste should be in conformance with WM – 3 Temporary Concrete Washout and Waste Management.</li> <li>• Do not wash sweepings from exposed aggregate concrete into a stormdrain system. Collect and return to aggregate base stockpile or dispose of properly.</li> </ul>

### Saw Cutting, Grinding, and Pavement Removal

- Shovel or vacuum saw-cut slurry and remove from site. Cover or barricade stormdrains during saw cutting to contain slurry.
- When paving involves AC, the following steps should be implemented to prevent the discharge of grinding residue, uncompacted or loose AC, task coats, equipment cleaners, or unrelated paving materials:
  - Minimize sand and gravel from new asphalt from getting into stormdrains, streets, and creeks by sweeping.
  - Old or spilled asphalt must be recycled or disposed as approved by the University's Representative.

Sources include EPA, SWRCB, Caltrans, CASQA  
**Non-Stormwater Management**



# Non-Stormwater Management

## NSM-7 Paving and Grinding

- AC grindings, pieces, or chunks used in embankments or shoulder backing must not be allowed to enter any stormdrain or watercourses. Install an erosion control BMP until the structure is stabilized or permanent controls are in place.
- Collect and remove all broken asphalt and recycle when practical; otherwise, dispose of properly.
- Any AC chunks and pieces used in embankments must be placed above the water table and covered by at least 1 foot of material.
- Do not allow saw-cut slurry to enter stormdrains or watercourses. Residue from grinding operations should be picked up by means of a vacuum attachment to the grinding machine, should not be allowed to flow across the pavement, and should not be left on the surface of the pavement. See also WM – 3 Temporary Concrete Washout and Waste Management.
- Dig out activities should not be conducted in the rain.
- Collect pavement dig out material by mechanical or manual methods. This material may be recycled if approved by the University’s Representative for use as shoulder backing or base material at locations approved by the University’s Representative.
- When approved by the University’s Representative, stockpile material removed from roadways away from stormdrain inlets, drainage ditches, and watercourses and stored consistent with WM – 5 Stockpile Management.
- Disposal or use of AC grindings shall be approved by the University’s Representative. See also WM – 3 Temporary Concrete Washout and Waste Management.

### Asphalt Concrete Paving

- If paving involves asphaltic cement concrete, follow these steps:
  - Do not allow sand or gravel placed over new asphalt to wash into stormdrains, streets, or watercourses. Vacuum or sweep loose sand and gravel and properly dispose of this waste by referring to WM – 2 Trash Containment.
  - Old asphalt must be disposed of properly. Collect and remove all broken asphalt from the site and recycle whenever possible.

### Portland Cement Concrete Paving

- Do not wash sweepings from exposed aggregate concrete into a stormdrain system. Collect and return to aggregate base stockpile or dispose of properly.
- Allow aggregate rinse to settle. Then allow rinse water to dry in a temporary pit as described in WM – 3 Temporary Concrete Washout and Waste Management.
- Do not allow saw-cut Portland Concrete Cement (PCC) slurry to enter stormdrains or watercourses.

Sources include EPA, SWRCB, Caltrans, CASQA  
**Non-Stormwater Management**



# Non-Stormwater Management

## NSM-7 Paving and Grinding

### Sealing Operations

- During chip seal application and sweeping operations, petroleum or petroleum covered aggregate must not be allowed to enter any stormdrain or water courses. Apply temporary perimeter controls until structure is stabilized.
- Drainage inlet structures and manholes shall be covered with filter fabric during application of seal coat, tack coat, slurry seal, and/or fog seal. Once these coats are complete remove the filter fabric and install approved stormdrain inlet protection.
- Seal coat, tack coat, slurry seal, or fog seal shall not be applied if rainfall is predicted to occur during the application or curing period.

### Paving Equipment

- Leaks and spills from paving equipment can contain toxic levels of heavy metals and oil and grease. Place drip pans or absorbent materials under paving equipment when not in use. Clean up spills with absorbent materials rather than burying. See NSM – Vehicle and Equipment Practices and WM – 6 Spill Prevention and Control.
- Substances used to coat asphalt transport trucks, asphalt trucks, and asphalt spreading equipment shall not contain soap and shall be non-foaming and non-toxic.
- Place plastic materials under asphaltic concrete (AC) paving equipment while not in use, to catch and/or contain drips and leaks.
- Paving equipment parked onsite shall be parked over plastic to prevent soil contamination.
- Clean asphalt-coated equipment offsite whenever possible. When cleaning dry, hardened asphalt from equipment, manage hardened asphalt debris as described in WM – 2 Trash Containment. Any cleaning onsite shall follow NSM – 3 Vehicle and Equipment Practices.

### Thermoplastic Striping

- All thermoplastic striper and pre-heater equipment shutoff valves shall be inspected to ensure that they are working properly to prevent leaking thermoplastic from entering the stormdrain inlets, the stormwater drainage system, or watercourses.
- The pre-heater shall be filled carefully to prevent splashing or spilling of hot thermoplastic. Leave six inches of space at the top of the pre-heater container when filling thermoplastic to allow room for material to move when the vehicle is deadheaded.
- Contractor shall not pre-heat, transfer, or load thermoplastic near stormdrain inlets or watercourses.
- Clean truck beds daily of loose debris and melted thermoplastic. Thermoplastic

Sources include EPA, SWRCB, Caltrans, CASQA  
**Non-Stormwater Management**



# Non-Stormwater Management

## NSM-7 Paving and Grinding

waste shall be disposed of properly.

### Raised/Recessed Pavement Marker Application and Removal

- Do not transfer or load bituminous material near stormdrain inlets, the stormwater drainage system, or watercourses.
- Melting tanks shall be loaded with care and not filled to beyond six inches from the top to leave room for splashing when vehicle is deadheaded.
- When servicing or filling melting tanks, ensure all pressure is released before removing lids to avoid spills.
- On large scale Projects, use mechanical or manual methods to collect excess bituminous material from the roadway after removal of markers.
- Waste shall be disposed of properly.

### Maintenance & Inspection

- Inspect BMPs prior to forecast rain, daily during extended rain events, after rain events, and weekly throughout the life of the Project.
- Inspect and maintain machinery regularly to minimize leaks and drips.
- Ensure that employees and subcontractors are implementing appropriate measures during paving operations.
- Keep ample supplies of drip pans or absorbent materials onsite.



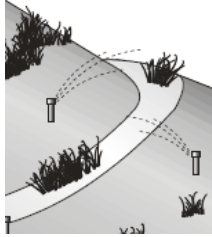

# Non-Stormwater Management

## NSM-8 Potable Water/Irrigation

Definition	Potable water/irrigation management consists of practices and procedures to manage the discharge of potential pollutants generated during discharges from irrigation water lines, landscape irrigation, lawn or garden watering, planned and unplanned discharges from potable water sources, water line flushing, and hydrant flushing.
Purpose	Manage discharges to reduce or eliminate pollution flowing into the stormdrain system or leaving the Project site.
Conditions Where the Practice Applies	Implement this BMP whenever potable water or irrigation water discharges occur at or enter a construction site.
Specifications: Design and Installation	<ul style="list-style-type: none"> <li>• Direct water from offsite sources around or through a construction site, where feasible, in a way that minimizes contact with the construction site.</li> <li>• Discharges from water line flushing should be reused for landscaping purposes where feasible. If no landscaping exists and the water can not be captured and used at another landscaped site, then with the approval of the University's Representative the line flushing may be discharged to a stormdrain. Ensure the area around the stormdrain where the line flushing will discharge to is clean and free of sediment and pollutants. Do not allow the line flushing to carry sediment or contaminants to the stormdrain system.</li> <li>• Shut off the water source to broken lines, sprinklers, or valves as soon as possible to prevent excess water flow.</li> <li>• Protect downstream stormwater drainage systems and watercourses from water pumped or bailed from trenches excavated to repair water lines.</li> <li>• Inspect irrigated areas within the construction limits for excess watering. Adjust watering times and schedules to ensure that the appropriate amount of water is being used and to minimize runoff. Consider factors such as soil structure, grade, time of year, and type of plant material in determining the proper amounts of water for a specific area.</li> <li>• The approval of the University's Representative is required prior to commencing any washing activities that could discharge to the stormdrain.</li> </ul>
Maintenance & Inspection	<ul style="list-style-type: none"> <li>• Inspect and verify that activity-based BMPs are in place prior to the commencement of associated activities.</li> <li>• Inspect BMPs prior to forecast rain, daily during extended rain events, after rain events, and weekly throughout the life of the Project.</li> <li>• Inspect BMPs subject to non-stormwater discharges daily while non-stormwater discharges occur.</li> <li>• Repair broken water lines as soon as possible.</li> <li>• Inspect irrigated areas regularly for signs of erosion and/or discharge.</li> </ul>

Sources include EPA, SWRCB, Caltrans, CASQA  
**Non-Stormwater Management**



# Non-Stormwater Management

## NSM-9 Material Use

Definition	Use alternative products, minimize hazardous material use onsite, and train employees and subcontractors to prevent or reduce the discharge of pollutants to the stormdrain system or watercourses from material use.
Purpose	Prevent or reduce the discharge of pollutants to the stormdrain system or watercourses from material use.
Conditions Where the Practice Applies	<p>This BMP is suitable for use at all construction Projects. These procedures apply when the following materials are used or prepared onsite:</p> <ul style="list-style-type: none"> <li>• Pesticides and herbicides</li> <li>• Fertilizers</li> <li>• Detergents</li> <li>• Plaster</li> <li>• Petroleum products such as fuel, oil, and grease</li> <li>• Asphalt and other concrete components</li> <li>• Other hazardous chemicals such as acids, lime, glues, adhesives, paints, solvents, and curing compounds</li> <li>• Concrete compounds</li> <li>• Other materials that may be detrimental if released to the environment</li> </ul>
Specifications: Design and Installation	<p>The following steps should be taken to minimize risks:</p> <ul style="list-style-type: none"> <li>• Minimize use of hazardous materials onsite.</li> <li>• Follow manufacturer instructions regarding uses, protective equipment, ventilation, flammability, and mixing of chemicals.</li> <li>• Train personnel who use pesticides. The California Department of Pesticide Regulation and county agricultural commissioners license pesticide dealers, certify pesticide applicators, and conduct onsite inspections.</li> <li>• Do not over-apply fertilizers, herbicides, and pesticides. Prepare only the amount needed. Follow the recommended usage instructions. Over-application is expensive and environmentally harmful. Unless on steep slopes, till fertilizers into the soil rather than hydro seeding. Apply surface dressings in several smaller applications, as opposed to one large application, to allow time for infiltration and to avoid excess material being carried offsite by runoff. Do not apply these chemicals just before it rains.</li> <li>• Train employees and subcontractors in proper material use.</li> <li>• Supply Material Safety Data Sheets (MSDS) for all materials.</li> <li>• Dispose of latex paint and paint cans, used brushes, rags, absorbent materials, and drop cloths, when thoroughly dry and are no longer hazardous, with other construction debris.</li> <li>• Do not remove the original product label; it contains important safety and disposal</li> </ul>

Sources include EPA, SWRCB, Caltrans, CASQA

**Non-Stormwater Management**



# Non-Stormwater Management

## NSM-9 Material Use

information. Use the entire product before disposing of the container.

- Mix paint indoors or in a containment area. Never clean paintbrushes or rinse paint containers into a street, gutter, stormdrain, waterway, or anywhere on the Project site where it could be spilled onto the ground and potentially pollute the stormdrain system.
- For water-based paint, clean brushes to the extent practicable, and rinse to a concrete washout bin. For oil-based paints, clean brushes to the extent practicable, and filter and reuse thinners and solvents.
- Use recycled and less hazardous products when practical. Recycle residual paints, solvents, non-treated lumber, and other materials.
- Use materials only where and when needed to complete the construction activity. Use safer alternative materials as much as possible. Reduce or eliminate use of hazardous materials onsite when practical.
- Require Contractors to complete the “Report of Chemical Spray Forms” when spraying herbicides and pesticides.
- Keep an ample supply of spill clean up material near use areas. Train employees in spill clean up procedures.
- Avoid exposing applied materials to rainfall and runoff unless sufficient time has been allowed for them to dry.

### Maintenance & Inspection

- Inspect and verify that activity-based BMPs are in place prior to the commencement of associated activities.
- Inspect BMPs prior to forecast rain, daily during extended rain events, after rain events, and weekly throughout the life of the Project.
- Spot check employees and subcontractors throughout the job to ensure appropriate practices are being employed.

## Waste Management Introduction

Construction Projects generate large amounts of building-related waste, which can end up polluting stormwater runoff if not properly managed. The Contractor is required to design proper management procedures and practices to prevent or reduce the discharge of pollutants to stormwater from solid or liquid wastes that will be generated at your site. Practices such as trash disposal, recycling, proper material handling, and cleanup measures can reduce the potential for stormwater runoff to pick up construction site wastes and discharge them to surface waters. All workers on the Project site must be adequately trained on proper material use, storage, and waste disposal. The Contractor is required to implement a comprehensive set of waste-management practices for hazardous or toxic materials including storage, handling, inventory, and clean-up procedures. The Contractor is required to implement, at a minimum, the following applicable measures, or equivalent BMPs with the approval of the University's Representative.

### **WM – 1 Material Delivery and Storage**

Prevent, reduce, or eliminate the discharge of pollutants from material delivery and storage to the stormwater system or watercourses by minimizing the storage of hazardous materials onsite, storing materials in a designated area, installing secondary containment, conducting regular inspections, and training employees and subcontractors.

### **WM – 2 Trash Containment**

Provide designated waste collection areas and containers, arranging for regular disposal, and training employees and subcontractors.

### **WM – 3 Temporary Concrete Washout and Waste Management**

Procedures and practices such as conducting washout offsite, performing onsite washout in a designated area, and training employees and subcontractors to prevent or reduce the discharge of pollutants to stormwater from concrete waste. Concrete wash water is alkaline and contains high levels of chromium, which can leach into the ground and contaminate groundwater.

### **WM – 4 Sanitary Waste Management**

Practices and procedures such as providing convenient, well-maintained facilities, and arranging for regular service and disposal prevents the discharge of pollutants to stormwater from sanitary and septic waste.

### **WM – 5 Stockpile Management**

Stockpile Management procedures and practices are designed to reduce or eliminate air and stormwater pollution from stockpiles of soil, paving materials such as Portland Cement Concrete (PCC) rubble, Asphalt Concrete (AC), asphalt concrete rubble, aggregate base, aggregate sub base or pre-mixed aggregate, asphalt minder (so called "cold mix" asphalt), and pressure treated wood.

### **WM – 6 Spill Prevention and Control**

Reduce the chance for spills, stop the source of spills, contain and clean up spills, properly dispose of spill materials, and train employees and subcontractors.

**WM – 7 Hazardous Waste Management**

These are procedures and practices to minimize or eliminate the discharge of pollutants from construction site hazardous waste to the stormdrain systems or to watercourses.

**WM – 8 Contaminated Soil Management**

Conduct pre-construction surveys, inspect excavations regularly, and remediate contaminated soil promptly to prevent or reduce the discharge of pollutants to stormwater from contaminated soil and highly acidic or alkaline soils.

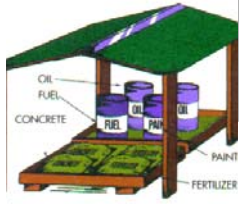

# Waste Management

## WM-1 Material Delivery and Storage

Definition	Prevent, reduce, or eliminate the discharge of pollutants from material delivery and storage to the stormwater system or watercourses by minimizing the storage of hazardous materials onsite, storing materials in a designated area, installing secondary containment, conducting regular inspections, and training employees and subcontractors.
Purpose	Minimize or eliminate the exposure of stormwater to construction materials to prevent pollution of the stormwater system.
Conditions Where the Practice Applies	<p>These procedures are suitable for use at all construction sites with delivery and storage of the following materials:</p> <ul style="list-style-type: none"> <li>• Soil stabilizers and binders</li> <li>• Pesticides and herbicides</li> <li>• Fertilizers</li> <li>• Detergents</li> <li>• Plaster</li> <li>• Petroleum products such as fuel, oil, and grease</li> <li>• Asphalt and concrete components</li> <li>• Hazardous chemicals such as acids, lime, glues, adhesives, paints, solvents, and curing compounds</li> <li>• Concrete compounds</li> <li>• Other materials that may be detrimental if released to the environment</li> </ul>
Specifications: Design and Installation	<p>The following steps should be taken to minimize risk:</p> <ul style="list-style-type: none"> <li>• Material Safety Data Sheets (MSDS) should be supplied for all materials stored.</li> <li>• Construction site areas should be designated for material delivery and storage.</li> <li>• Temporary storage area should be located close to the entrance of the site but away from vehicular traffic to prevent accidents. Also locate storage areas away from the Project perimeter, waterways, and stormdrains.             <ul style="list-style-type: none"> <li>• Avoid transport near drainage paths or waterways.</li> <li>• Surround with earth berms.</li> </ul> </li> <li>• Material storage areas shall be covered. Store materials in secondary containment including non-reactive materials such as detergents, oil, grease, and paints.</li> <li>• Do not store chemicals, drums, or bagged materials directly on the ground. Place these items in secondary containment.</li> <li>• Storage of reactive, ignitable, or flammable liquids must comply with the fire codes of your area. Contact the Fire Marshal at the UCSB Environmental Health &amp; Safety department on campus to review site materials, quantities, and proposed storage area to determine specific requirements. See the Flammable Sources include EPA, SWRCB, Caltrans, CASQA</li> </ul>

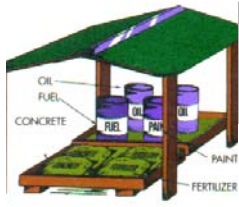

# Waste Management

## WM-1 Material Delivery and Storage

and Combustible Liquid Code, NFPA30.

- Keep an up to date inventory of materials delivered and stored onsite.
- Hazardous materials storage onsite should be minimized.
- Hazardous materials should be handled as infrequently as possible.
- Chemicals should be kept in their original labeled containers.
- Employees and subcontractors should be trained on the proper material delivery and storage practices.
- Employees trained in emergency spill cleanup procedures must be present when dangerous materials or liquid chemicals are unloaded.
- If residual materials remain on the ground after construction is complete, properly remove materials and any contaminated soil. See WM – 8 Contaminated Soil Management. If the area is to be paved, pave as soon as materials are removed to stabilize the soil.

### Material Storage Areas and Practices

- All temporary containment facilities and material storage areas shall be covered and have secondary containment.
- A temporary containment facility should provide for a spill containment volume able to contain precipitation from a 25 year storm event, plus the greater of 10% of the aggregate volume of all containers or 100% of the capacity of the largest container within its boundary, whichever is greater.
- A temporary containment facility should be impervious to the materials stored therein for a minimum contact time of 72 hours.
- A temporary containment facility should be maintained free of accumulated rainwater and spills. In the event of spills or leaks, accumulated rainwater and spills should be collected and placed into drums. These liquids should be handled as hazardous waste unless testing determines them to be non-hazardous. All collected liquids or non-hazardous liquids should be sent to an approved disposal site.
- Proper storage instructions should be posted at all times in an open and conspicuous location.
- Sufficient separation should be provided between stored containers to allow for spill cleanup and emergency response access.
- Incompatible materials, such as chlorine and ammonia, should not be stored in the same temporary containment facility.
- Materials should be stored in their original containers and the original product labels should be maintained in place in a legible condition. Damaged or otherwise illegible labels should be replaced immediately.
- Liquids, petroleum products, and substances listed in 40 CFR Parts 110, 117, or 302 should be stored in approved containers and drums and should not be overfilled. Containers and drums should be placed in temporary containment

Sources include EPA, SWRCB, Caltrans, CASQA

**Waste Management**

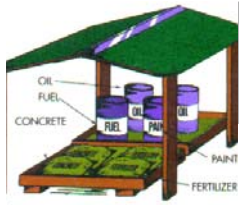

# Waste Management

## WM-1 Material Delivery and Storage

facilities for storage.

- Bagged and boxed materials should be stored on pallets and should not be allowed to accumulate on the ground. To provide protection from wind and rain throughout the rainy season, bagged and boxed materials should be covered during non-working days and prior to and during rain events.
- Stockpiles should be protected in accordance with WM – 5 Stockpile Management.
- Materials should be stored indoors within existing structures or sheds when available.
- An ample supply of appropriate spill clean up material should be kept near storage areas.

### Material Delivery Practices

- Keep an accurate, up-to-date inventory of material delivered and stored onsite.
- Arrange for employees trained in emergency spill cleanup procedures to be present when dangerous materials or liquid chemicals are unloaded.

### Spill Cleanup

- Contain and clean up any and all spills immediately.
- Properly remove and dispose of any hazardous materials or contaminated soil if significant residual materials remain on the ground after construction is complete. See BMP Contaminated Soil Management.

### Maintenance & Inspection

- Inspect and verify that activity-based BMPs are in place prior to the commencement of associated activities.
- Inspect BMPs prior to forecast rain, daily during extended rain events, after rain events, and weekly throughout the life of the Project.
- Keep an ample supply of spill cleanup materials near the storage area.
- Keep storage areas clean, well organized, and equipped with ample cleanup supplies as appropriate for the materials being stored.
- Repair or replace perimeter controls, containment structures, covers, and liners as needed to maintain proper function.





# Waste Management

## WM-2 Trash Containment

Definition	Provide designated waste collection areas and containers, arranging for regular disposal, and training employees and subcontractors.
Purpose	Prevent or reduce the discharge of pollutants to stormwater from solid or construction waste.
Conditions Where the Practice Applies	<p>This BMP is suitable for construction sites where the following wastes are generated or stored:</p> <ul style="list-style-type: none"> <li>• Solid waste generated from trees and shrubs removed during land clearing, demolition of existing structures (rubble), and building construction.</li> <li>• Packaging materials including wood, paper, and plastic.</li> <li>• Scrap or surplus building materials including scrap metals, rubber, plastic, glass pieces, and masonry products.</li> <li>• Domestic wastes including food containers such as beverage cans, coffee cups, paper bags, plastic wrappers, and cigarettes.</li> <li>• Construction wastes including brick, mortar, timber, steel and metal scraps, pipe and electrical cuttings, non-hazardous equipment parts, Styrofoam and other materials used to transport and package construction materials.</li> <li>• Planting wastes, including vegetative material, plant containers, and packaging materials.</li> </ul>
Specifications: Design and Installation	<p>The following steps will help keep a clean site and reduce stormwater pollution:</p> <ul style="list-style-type: none"> <li>• Select designated waste collection areas onsite.</li> <li>• Inform trash-hauling Contractors that only watertight dumpsters with lids will be accepted for onsite use. Inspect dumpsters for leaks and repair any dumpster that is not watertight.</li> <li>• Provide an adequate number of containers with lids to keep rain out, prevent loss of wastes when it is windy, and to keep birds and animals out.</li> <li>• Plan for additional containers and more frequent pickup during the demolition phase of construction.</li> <li>• Collect site trash daily throughout the life of the Project, especially during the rainy and windy conditions.</li> <li>• Remove solid waste promptly since erosion and sediment control devices tend to collect litter.</li> <li>• Make sure that toxic liquid wastes (used oils, solvents, and paints) and chemicals (acids, pesticides, additives, curing compounds) are not disposed of in dumpsters designated for construction debris.</li> <li>• Do not hose out dumpsters on the construction site. Leave dumpster cleaning to the trash hauling Contractor.</li> <li>• Arrange for regular waste collection before containers overflow. Do not allow</li> </ul> <p style="text-align: right;">Sources include EPA, SWRCB, Caltrans, CASQA</p> <p style="text-align: right;"><b>Waste Management</b></p>



# Waste Management

## WM-2 Trash Containment

containers to overflow.

- Clean up immediately if a container does spill.
- Make sure that construction waste is collected, removed, and disposed of only at authorized disposal areas.

### Education

- Have the Contractor's superintendent or representative oversee and enforce proper solid waste management procedures and practices.
- Instruct employees and subcontractors on identification of solid waste and hazardous waste.
- Educate employees and subcontractors on solid waste storage and disposal procedures.
- Hold regular meetings to discuss and reinforce disposal procedures (incorporate into regular weekly meetings).
- Require that employees and subcontractors follow solid waste handling and storage procedures.
- Prohibit littering by employees, subcontractors, and visitors.
- Minimize production of solid waste materials whenever possible.

### Collection, Storage, and Disposal

- Littering on the Project site is prohibited.
- To prevent clogging of the stormwater drainage system, litter and debris removal from drain gates, trash racks, and ditch lines should be a priority.
- Trash receptacles should be provided in the Contractor's yard, field trailer areas, and at locations where workers congregate for lunch and break periods.
- Trash receptacles from work areas within the construction limits of the Project site should be collected and placed in watertight dumpsters at least weekly, regardless of whether the litter was generated by the Contractor, the public, or others. Collected litter and debris should not be placed in or next to stormdrain inlets, stormwater drainage systems, watercourses, or near the site perimeter.
- Dumpsters of sufficient size and number should be provided to contain the solid waste generated by the Project.
- Full dumpsters should be removed from the Project site and the contents should be disposed of properly by trash hauling contractor.
- Construction material visible to the public should be stored or stacked in an orderly manner.
- Stormwater runoff should be prevented from contacting stored solid waste through the use of berms, dikes, or other temporary diversion structures or through the use of measures to elevate waste from site surfaces.
- Solid waste storage areas should be located at least 50 feet from drainage facilities

Sources include EPA, SWRCB, Caltrans, CASQA

**Waste Management**



# Waste Management

## WM-2 Trash Containment

and watercourses and should not be located in areas prone to flooding or ponding.

- Dispose of planting waste in watertight dumpsters.
- Segregate potentially hazardous waste from non-hazardous construction site waste.
- Make sure that toxic liquid wastes (used oils, solvents, and paints) and chemicals (acids, pesticides, additives, curing compounds) are not disposed of in dumpsters designated for construction debris.
- For disposal of hazardous waste, see WM – 7 Hazardous Waste Management. Have hazardous waste hauled to an appropriate disposal and/or recycling facility.
- Salvage or recycle useful vegetation debris, packaging and surplus building materials when practical. For example, trees and shrubs from land clearing can be used as a brush barrier or converted into wood chips, then used as mulch on graded areas. Wood pallets, cardboard boxes, and construction scraps can also be recycled.

### Maintenance & Inspection

- Inspect and verify that activity-based BMPs are in place prior to the commencement of associated activities.
- Inspect BMPs prior to forecast rain, daily during extended rain events, after rain events, and weekly throughout the life of the Project.
- Inspect construction waste area regularly.
- Arrange for regular waste collection.
- Monitor employees, subcontractors, and visitors and ensure no littering.

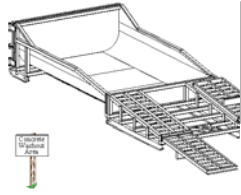

# Waste Management

## WM-3 Temporary Concrete Washout and Waste Management

Definition	Procedures and practices such as conducting washout offsite, performing onsite washout in a designated area, and training employees and subcontractors to prevent or reduce the discharge of pollutants to stormwater from concrete waste. Concrete wash water is alkaline and contains high levels of chromium, which can leach into the ground and contaminate groundwater.
Purpose	Prevent or reduce the discharge of pollutants to stormwater from concrete waste.
Conditions Where the Practice Applies	<p>Concrete waste management procedures and practices are implemented on construction Projects where:</p> <ul style="list-style-type: none"> <li>• Concrete is used as a construction material or where concrete dust and debris result from demolition activities.</li> <li>• Slurries containing Portland Cement Concrete (PCC) or Asphalt Concrete (AC) are generated, such as from saw cutting, coring, grinding, grooving, and hydro-concrete demolition.</li> <li>• Concrete trucks and other concrete-coated equipment are washed onsite.</li> <li>• Mortar-mixing stations exist.</li> </ul>
Specifications: Design and Installation	<p>The following steps will help reduce stormwater pollution from concrete wastes:</p> <ul style="list-style-type: none"> <li>• Discuss the concrete management techniques described in this BMP (such as handling concrete waste and washout) with the ready-mix concrete supplier before any deliveries are made.</li> <li>• Incorporate requirements for concrete waste management into material supplier and subcontractor agreements.</li> <li>• Store dry and wet materials under cover, in secondary containment, away from drainage areas and Project perimeter.</li> <li>• Avoid mixing excess amounts of fresh concrete.</li> <li>• Perform washout of concrete trucks offsite or in a designated area only.</li> <li>• Do not wash out concrete trucks into stormdrains, open ditches, streets, streams, near the Project perimeter, or anywhere else onsite except a designated concrete washout bin.</li> <li>• Do not allow excess concrete to be dumped onsite, except in a designated concrete washout bin.</li> <li>• For onsite washout:             <ul style="list-style-type: none"> <li>• Locate washout bin at least 50 feet from stormdrains, open ditches, water bodies, or the Project perimeter. Do not allow runoff from this area.</li> <li>• Wash out wastes into the concrete washout bin where the concrete can set, be broken up, and then disposed of properly.</li> </ul> </li> </ul>

Sources include EPA, SWRCB, Caltrans, CASQA  
**Waste Management**

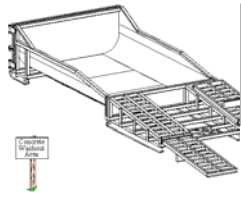

# Waste Management

## WM-3 Temporary Concrete Washout and Waste Management

- Avoid creating runoff by draining water to a bermed area or by collecting the water waste when washing concrete to remove fine particles and expose the aggregate.
- Do not wash sweepings from exposed aggregate concrete into the street, stormdrain system, or off the Project site.

### Education

- Educate employees, subcontractors, and suppliers on the concrete waste management techniques described herein.
- Arrange for Contractor's superintendent or representative to oversee and enforce concrete waste management procedures.

### Concrete Slurry Wastes

- PCC and AC waste should not be allowed to enter stormdrains, watercourses, or leave the Project perimeter.
- PCC and AC waste should be collected and disposed of or placed in a temporary concrete washout facility.
- A sign should be installed adjacent to each temporary concrete washout bin to inform concrete equipment operators to utilize the proper facilities.
- A foreman or construction supervisor should monitor onsite concrete working tasks, such as saw cutting, coring, grinding, and grooving to ensure proper methods are implemented.
- Saw-cut PCC slurry should not be allowed to enter stormdrains or watercourses. Residue from grinding operations should be picked up by means of a vacuum attachment to the grinding machine. Saw cutting residue should not be allowed to flow across the pavement and should not be left on the surface of the pavement. See also NSM – 7 Paving and Grinding.
- Slurry residue should be vacuumed and disposed of in a concrete washout bin and allowed to dry.

### Onsite Temporary Concrete Washout Bin

- Temporary concrete washout bins should be located a minimum of 50 feet from stormdrain inlets, open drainage facilities, watercourses, and the Project perimeter. Each bin should be located away from construction traffic or access areas to prevent disturbance or tracking.
- A sign should be installed adjacent to each washout facility to inform concrete equipment operators to utilize the proper facilities. If the concrete washout bin is moved to a different part of the site the sign needs to be moved with it.
- Temporary concrete washout bins should be emptied regularly to ensure proper

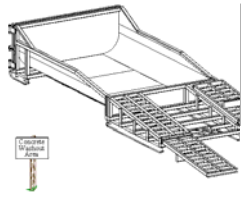

# Waste Management

## WM-3 Temporary Concrete Washout and Waste Management

management of all liquid and concrete waste generated by washout operations.

- Washout of concrete trucks should be performed in designated concrete washout bins only.
- Concrete from mixer truck chutes should be washed into concrete washout bins.
- Concrete washout from concrete pumper bins can be washed into concrete pumper trucks and discharged into designated concrete washout bins or properly disposed offsite.
- Once concrete wastes are washed into the designated area and allowed to harden, the concrete should be broken up, removed, and disposed of properly. Empty the concrete washout bin on a regular basis.
- Concrete washout bins should be sturdy, prefabricated concrete washout containers that are delivered to the site.
- To prevent leaks on the Project site, ensure that the concrete washout bin is watertight and has no cracks or breaks.
- Ensure that the company handling the concrete waste properly disposes of all materials. Preference should be given to companies that recycle collected material.

### Maintenance & Inspection

- Inspect and verify that activity-based BMPs are in place prior to the commencement of associated activities.
- Inspect BMPs prior to forecast rain, daily during extended rain events, after rain events, and weekly throughout the life of the Project.
- Check all concrete washout bins daily to determine if they have been filled to 75% capacity, which is when materials need to be removed.
- Inspect the concrete washout bin daily to ensure the container is not leaking or nearing 75% capacity.
- Inspect the site daily to ensure employees and subcontractors are not washing out on site in non-designated concrete washout bins. Provide more education, install additional signage, or place additional concrete washout bins in more convenient locations if employees and subcontractors are not using the concrete washout bins properly or are washing out on the Project site in non-designated locations.
- Temporary concrete washout bins should be maintained to provide adequate holding capacity. Maintaining temporary concrete washout bins should include removing and disposing of hardened concrete and returning the bin to a functional condition.
- Concrete washout bins must be cleaned out once the washout is 75% full.

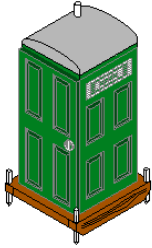

# Waste Management

## WM-4 Sanitary Waste Management

Definition	Practices and procedures such as providing convenient, well-maintained facilities, and arranging for regular service and disposal prevents the discharge of pollutants to stormwater from sanitary and septic waste.
Purpose	Proper sanitary and septic waste management prevent the discharge of pollutants to stormwater from sanitary and septic waste.
Conditions Where the Practice Applies	Sanitary septic waste management practices are suitable for use at all construction sites that use temporary or portable sanitary and septic waste systems.
Specifications: Design and Installation	Sanitary or septic wastes should be treated or disposed of in accordance with state and local requirements. In many cases, one contract with a local facility supplier will be all that it takes to make sure sanitary wastes are properly disposed.

### Storage and Disposal Procedures

- Temporary sanitary facilities should be located away from drainage facilities, watercourses, the Project perimeter, and from traffic circulation. When there is a risk of high winds, temporary sanitary facilities should be secured (staked down or tied to a sturdy structure) to prevent overturning.
- Temporary sanitary facilities should be located on a permeable surface at all times. If a temporary sanitary facility needs to be placed on an impermeable surface than it must be placed in an overflow pan or bin.
- Wastewater should not be discharged or buried within the Project site.
- Only reputable, licensed sanitary and septic waste haulers should be used.
- Sanitary facilities should be located in a convenient location.
- Untreated raw wastewater should never be discharged or buried.
- Temporary septic systems should treat wastes to appropriate levels before discharging.
- Sanitary and septic facilities should be maintained in good working order by a licensed service.
- Regular waste collection by a licensed hauler should be arranged before facilities are full. Sanitary and septic facilities should never overflow.

### Education

- Educate employees, subcontractors, and suppliers on sanitary and septic waste storage and disposal procedures.
- Educate employees, subcontractors, and suppliers of potential dangers to humans and the environment from sanitary and septic wastes.
- Instruct employees, subcontractors, and suppliers in identification of sanitary and

Sources include EPA, SWRCB, Caltrans, CASQA  
**Waste Management**

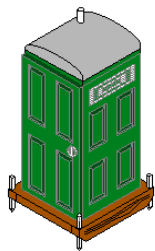

# Waste Management

## WM-4 Sanitary Waste Management

septic waste.

- Hold regular meetings to discuss and reinforce disposal procedures (incorporate into regular safety meetings).
- Establish a continuing education program to indoctrinate new employees.

### Maintenance & Inspection

- Inspect and verify that activity-based BMPs are in place prior to the commencement of associated activities.
- Inspect BMPs prior to forecast rain, daily during extended rain events, after rain events, and weekly throughout the life of the Project.
- Arrange for regular waste collection.
- If high winds are expected, portable sanitary facilities must be secured with spikes to prevent over turning.





# Waste Management

## WM-5 Stockpile Management

Definition	Stockpile Management procedures and practices are designed to reduce or eliminate air and stormwater pollution from stockpiles of soil, paving materials such as Portland Cement Concrete (PCC) rubble, Asphalt Concrete (AC), asphalt concrete rubble, aggregate base, aggregate sub base or pre-mixed aggregate, asphalt minder (so called “cold mix” asphalt), and pressure treated wood.
Purpose	To prevent air and stormwater pollution from stockpiles of various construction materials.
Conditions Where the Practice Applies	Implement in all Projects that stockpile soil and other materials.
Specifications: Design and Installation	<p>Protection of stockpiles is a year-round requirement. To properly manage stockpiles:</p> <ul style="list-style-type: none"> <li>• Locate stockpiles a minimum of 50 feet away from concentrated flows of stormwater, stormdrain inlets, and the site perimeter.</li> <li>• Protect all stockpiles from stormwater runoff using a temporary perimeter sediment barrier such as gravel bags, fiber rolls, or cutback curb.</li> <li>• Protect all stockpiles from stormwater and wind erosion by completely covering with some type of tarp or covering. Secure the tarp with stakes or gravel bags to ensure the tarp does not blow off or expose any portion of the stockpile. Stockpiles must be covered at all times.</li> <li>• Implement wind erosion control practices as appropriate on all stockpiled material. For specific information, see WEC – 1 Dust Control.</li> <li>• Manage stockpiles of contaminated soil in accordance with WM – 8 Contaminated Soil Management.</li> <li>• Place bagged materials in the material storage area, in secondary containment, and under cover.</li> </ul>

### Protection of Non-Active Stockpiles

Non-active stockpiles of the identified materials should be protected further as follows:

#### *Soil Stockpiles*

- Soil stockpiles should be covered or protected with soil stabilization measures and a temporary perimeter sediment barrier at all times.

#### *Stockpiles of Portland Cement Concrete Rubble, Asphalt Concrete, Asphalt Concrete Rubble, Aggregate Base, or Aggregate Sub Base*

- The stockpiles should be covered or protected with soil stabilization measures and a temporary perimeter sediment barrier at all times.

#### *Stockpiles of “Cold Mix”*

- Soil stockpiles should be placed on and covered with plastic or comparable

Sources include EPA, SWRCB, Caltrans, CASQA

**Waste Management**



# Waste Management

## WM-5 Stockpile Management

material at all times.

*Stockpiles/Storage of Pressure Treated Wood with Copper, Chromium, and Arsenic or Ammonical, Copper, Zinc, and Arsenate*

- Treated wood should be covered with plastic or comparable material at all times.

### Protection of Active Stockpiles

- All stockpiles should be covered and protected with a temporary linear sediment barrier prior to the onset of precipitation.
- Stockpiles of “cold mix” should be placed on and covered with plastic or comparable material prior to the onset of precipitation.

### Maintenance & Inspection

- Inspect and verify that activity-based BMPs are in place prior to the commencement of associated activities.
- Inspect BMPs prior to forecast rain, daily during extended rain events, after rain events, and weekly throughout the life of the Project.
- Repair and/or replace perimeter controls and covers as needed to keep them functioning properly. Ensure stockpiles are covered at all times and that the covers are properly secured or weighted down.



# Waste Management

## WM-6 Spill Prevention and Control

Definition	Reduce the chance for spills, stop the source of spills, contain and clean up spills, properly dispose of spill materials, and train employees and subcontractors.
Purpose	Prevent or reduce the discharge of leaks and spills.
Conditions Where the Practice Applies	<p>This BMP is suitable for all construction Projects. Spill control procedures are implemented anytime chemicals or hazardous substances are stored on the construction site, including the following materials:</p> <ul style="list-style-type: none"> <li>• Soil stabilizers/binders</li> <li>• Dust palliatives</li> <li>• Herbicides</li> <li>• Fertilizers</li> <li>• Deicing/anti-icing chemicals</li> <li>• Growth inhibitors</li> <li>• Fuels</li> <li>• Lubricants</li> <li>• Other petroleum distillates</li> </ul>
Specifications: Design and Installation	<p>The following steps will help reduce the stormwater impacts of leaks and spills:</p> <p><u>Education</u></p> <ul style="list-style-type: none"> <li>• Be aware that different materials pollute in different amounts. Make sure that each employee knows what a “significant spill” is for each material they use, and what is the appropriate response for “significant” and “insignificant” spills.</li> <li>• Educate employees and subcontractors on potential dangers to humans and the environment from spills and leaks.</li> <li>• Hold regular meetings to discuss and reinforce appropriate disposal procedures (incorporate into regular safety meetings).</li> <li>• Establish a continuing education program to indoctrinate new employees.</li> <li>• Have the Contractor’s superintendent or representative oversee and enforce proper spill prevention and control measures.</li> </ul> <p><u>General Measures</u></p> <ul style="list-style-type: none"> <li>• To the extent that the work can be accomplished safely, spills of oil, petroleum products, substances listed under 40 CFR Parts 11, 117, and 302, and sanitary and septic wastes should be contained and cleaned up immediately.</li> <li>• Store hazardous materials and wastes in covered watertight containers and protect from vandalism.</li> <li>• Place a stockpile of spill cleanup materials where it will be readily accessible.</li> <li>• Train employees in spill prevention and cleanup.</li> <li>• Designate responsible individuals to oversee and enforce control measures.</li> <li>• Spills should be covered and protected from stormwater runoff during rainfall to the extent that it doesn’t compromise clean up activities.</li> </ul>

Sources include EPA, SWRCB, Caltrans, CASQA

**Waste Management**



# Waste Management

## WM-6 Spill Prevention and Control

- Do not bury or wash spills with water.
- Store and dispose of used clean up materials, contaminated materials, and recovered spill material that is no longer suitable for the intended purpose in conformance with the provisions in applicable BMPs.
- Do not allow water used for cleaning and decontamination to enter stormdrains or watercourses. Collect and dispose of contaminated water in accordance with.
- Contain water overflow or minor water spillage and do not allow it to discharge into drainage facilities or watercourses.
- Place proper storage, cleanup, and spill reporting instructions for hazardous materials stored or used on the Project site in an open, conspicuous, and accessible location.
- Keep waste storage areas clean, well organized, and equipped with ample cleanup supplies as appropriate for the materials being stored. Perimeter controls, containment structures, covers, and liners should be repaired or replaced as needed to maintain proper function.

### Cleanup

- Clean up leaks and spills immediately.
- Use a rag for small spills on paved surfaces, a damp mop for general cleanup, and absorbent material for larger spills. If the spilled material is hazardous, then the used cleanup materials are also hazardous and must be sent to either a certified laundry (rags) or disposed of as hazardous waste.
- Never hose down or bury dry material spills. Clean up as much of the material as possible and dispose of properly.

### Minor Spills

- Minor spills typically involve small quantities of oil, gasoline, paint, etc. which can be controlled by the first responder at the discovery of the spill.
- Use absorbent materials on small spills rather than hosing down or burying the spill.
- Absorbent materials should be promptly removed and disposed of properly.
- Follow the practice below for a minor spill:
  - Contain the spread of the spill.
  - Recover spilled materials.
  - Clean the contaminated area and properly dispose of contaminated materials.

### Semi-Significant Spills

- Semi-significant spills still can be controlled by the first responder along with the aid of other personnel such as laborers and the foreman, etc. This response may require the cessation of all other activities.
- Spills should be cleaned up immediately:

Sources include EPA, SWRCB, Caltrans, CASQA

**Waste Management**



# Waste Management

## WM-6 Spill Prevention and Control

- Contain the spread of the spill.
- Notify the Project Foreman and the University's Representative immediately.
- If the spill occurs on paved or impermeable surfaces, clean up using "dry" methods (absorbent materials, cat litter and/or rags). Contain the spill by encircling with absorbent materials and do not let the spill spread widely.
- If the spill occurs in dirt areas, immediately contain the spill by constructing an earthen dike. Dig up and properly dispose of contaminated soil.
- If the spill occurs during rain, cover the spill with tarps or other material to prevent contaminating runoff. Clean area thoroughly once the rain event has stopped.

### Significant/Hazardous Spills

- For significant or hazardous spills that cannot be controlled by personnel in the immediate vicinity, the following steps should be taken:
  - Always notify the University's Representative first. Then, notify the local emergency response by dialing 911. In addition to 911, the Contractor will notify the proper county officials. It is the Contractor's responsibility to have all emergency phone numbers at the construction site.
  - Notify the Governor's Office of Emergency Services Warning Center, (916) 845-8911.
  - For spills of federal reportable quantities, in conformance with the requirements in 40 CFR Parts 110, 119, and 302, the Contractor should notify the National Response Center at (800) 424-8802.
  - Notification should first be made by telephone and followed up with a written report.
  - The services of a spills Contractor or a Haz-Mat team should be obtained immediately. Construction personnel should not attempt to clean up until the appropriate and qualified staffs have arrived at the Project site.
  - Other agencies which may need to be consulted include, but are not limited to, the UCSB Environmental Health & Safety Department, the Fire Department, the Public Works Department, the Coast Guard, the Highway Patrol, the campus Police, the City/County Police Department, Department of Toxic Substances, California Division of Oil and Gas, Cal/OSHA, etc.

### Reporting

- Report significant spills to local agencies, such as the UCSB Environmental Health & Safety Department and the Fire Department; they can assist in cleanup.
- Federal regulations require that any significant oil spill into a water body or onto an adjoining shoreline be reported to the National Response Center (NRC) at 800-424-8802 (24 hours).



# Waste Management

## WM-6 Spill Prevention and Control

### Vehicle and Equipment Maintenance

- If maintenance must occur onsite, use a designated area and a secondary containment, located away from drainage courses and the Project perimeter, to prevent the runoff of stormwater and the runoff of spills.
- Regularly inspect onsite vehicles and equipment for leaks and repair immediately.
- Check incoming vehicles and equipment (including delivery trucks, and employee and subcontractor vehicles) for leaking oil and fluids. Do not allow leaking vehicles or equipment onsite.
- Always use secondary containment, such as a drain pan or drop cloth, to catch spills or leaks when removing or changing fluids.
- Place drip pans or absorbent materials under paving equipment when not in use.
- Use absorbent materials on small spills rather than hosing down or burying the spill. Remove the absorbent materials promptly and dispose of properly.
- Promptly transfer used fluids to the proper waste or recycling drums. Don't leave full drip pans or other open containers lying around.
- Oil filters disposed of in trashcans or dumpsters can leak oil and pollute stormwater. Place the oil filter in a funnel over a waste oil-recycling drum to drain excess oil before disposal. Oil filters can also be recycled. Ask the oil supplier or recycler about recycling oil filters.
- Store cracked batteries in a non-leaking secondary container. Do this with all cracked batteries even if you think all the acid has drained out. If you drop a battery, treat it as if it is cracked. Put it into the containment area until you are sure it is not leaking.

### Vehicle and Equipment Fueling

- If fueling must occur onsite, use designated areas, located away from drainage courses, to prevent the runoff of stormwater and the runoff of spills.
- Discourage "topping off" of fuel tanks.
- Always use secondary containment, such as a drain pan, when fueling to catch spills/leaks.

### Maintenance & Inspection

- Inspect and verify that activity-based BMPs are in place prior to the commencement of associated activities.
- Inspect BMPs prior to forecast rain, daily during extended rain events, after rain events, and weekly throughout the life of the Project.
- Keep ample supplies of spill control and cleanup materials onsite, near storage, unloading, and maintenance areas.
- Update your spill prevention and control plan and stock cleanup materials as changes occur in the types of chemicals onsite.

Sources include EPA, SWRCB, Caltrans, CASQA  
**Waste Management**

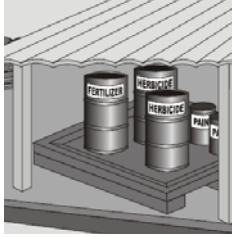

# Waste Management

## WM-7 Hazardous Waste Management

**Definition** These are procedures and practices to minimize or eliminate the discharge of pollutants from construction site hazardous waste to the stormdrain systems or to watercourses.

**Purpose** Prevent or reduce the discharge of pollutants to stormwater from hazardous waste through proper material use, waste disposal, and training of employees and subcontractors.

**Conditions Where the Practice Applies** This BMP applies to all construction Projects. Hazardous waste management practices are implemented on construction Projects that generate waste from the use of:

- Petroleum Products
- Concrete Curing Compounds
- Palliatives
- Septic Wastes
- Stains
- Wood Preservatives
- Asphalt Products
- Pesticides
- Acids
- Paints
- Solvents
- Roofing Tar
- Any material deemed a hazardous waste in California Title 22 Division 4.5, or listed in 40 CFR Parts 110, 117, 261, or 302

In addition, sites with existing structures may contain wastes, which must be disposed of in accordance with federal, state, and local regulations. These wastes include:

- Sandblasting grit mixed with lead-, cadmium-, or chromium-based paint
- PCBs (particularly in older transformers)
- Asbestos

**Specifications: Design and Installation** The following steps will help reduce stormwater pollution from hazardous wastes:

Material Use

- Wastes should be stored in sealed containers constructed of a suitable material and should be labeled as required by Title 22 CCR, Division 4.5 and 49 CFR Parts 172, 173, 178, and 179.
- All hazardous waste should be stored, transported, and disposed as required in Title 22 CCR, Division 4.5 and 49 CFR 261-263.
- Waste containers should be stored in temporary containment facilities that should comply with the following requirements:
  - Temporary containment facility should provide for a spill containment volume equal to 1.5 times the volume of all containers able to contain precipitation from a 25 year storm event, plus the greater of 10% aggregate

Sources include EPA, SWRCB, Caltrans, CASQA

**Waste Management**

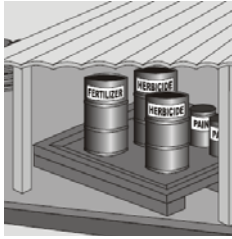

# Waste Management

## WM-7 Hazardous Waste Management

volume of all containers or 100% of the capacity of the largest tank within its boundary, whichever is greater.

- Temporary containment facility should be impervious to the materials stored there for a minimum contact time of 72 hours.
- Temporary containment facilities should be maintained free of accumulated rainwater and spills. In the event of spills or leaks, accumulated rainwater and spills should be placed into drums after each rainfall. These liquids should be handled as a hazardous waste unless testing determines them to be non-hazardous. Non-hazardous liquids should be sent to an approved disposal site.
- Sufficient separation should be provided between stored containers to allow for spill cleanup and emergency response access.
- Incompatible materials, such as chlorine and ammonia, should not be stored in the same temporary containment facility.
- Temporary containment facilities should be covered during non-working days and especially prior to rain events. Covered facilities may include use of plastic tarps for small facilities or constructed roofs with overhangs.
- Drums should not be overfilled and wastes should not be mixed.
- Containers of dry waste should be stored in secondary containment.
- Do not over-apply herbicides and pesticides. Prepare only the amount needed. Follow the recommended usage instructions. Over application is expensive and environmentally harmful. Apply surface dressings in several smaller applications, as opposed to one large application. Allow time for infiltration and avoid excess material being carried offsite by runoff. Do not apply these chemicals just before it rains. People applying pesticides must be certified in accordance with federal and state regulations.
- Paint brushes and equipment for water and oil based paints should be cleaned within a contained area and should not be allowed to contaminate site soils, watercourses, or drainage systems. Waste paints, thinners, solvents, residues, and sludges that cannot be recycled or reused should be disposed of as hazardous waste. When thoroughly dry, latex paint and paint cans, used brushes, rags, absorbent materials, and drop cloths should be disposed of as solid waste.
- The following actions should be taken with respect to temporary containment:
  - Ensure that adequate hazardous waste storage volume is available.
  - Ensure that hazardous waste collection containers are conveniently located.
  - Designate hazardous waste storage areas onsite away from stormdrains or watercourses, away from the site perimeter, and away from moving vehicles and equipment to prevent accidental spills.
  - Minimize production or generation of hazardous materials and hazardous waste on the job site.
  - Use containment berms in fueling and maintenance areas and where the

Sources include EPA, SWRCB, Caltrans, CASQA  
**Waste Management**



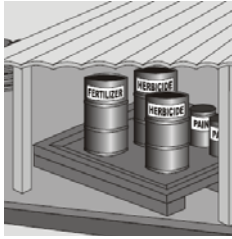

# Waste Management

## WM-7 Hazardous Waste Management

potential for spills is high.

- Segregate potentially hazardous waste from non-hazardous construction site debris.
- Keep liquid or semi-liquid hazardous waste in appropriate containers (closed drums or similar) and under cover.
- Clearly label all hazardous waste containers with the waste being stored and the date of accumulation.
- Place hazardous waste containers in secondary containment.
- Do not allow potentially hazardous waste materials to accumulate on the ground.
- Do not mix wastes.
- Use all of the product before disposing of the container.
- Do not remove the original product label; it contains important safety disposal information.

### Waste Recycling Disposal

- Select designated hazardous waste collection areas onsite.
- Hazardous materials and wastes should be stored in covered containers and protected from vandalism.
- Place hazardous waste containers in secondary containment.
- Do not mix wastes, this can cause chemical reactions, making recycling impossible and complicating disposal.
- Recycle any useful materials such as used oil or water-based paint.
- Make sure that toxic liquid wastes (used oils, solvents, and paints) and chemicals (acids, pesticides, additives, curing compounds) are not disposed of in dumpsters designated for construction debris.
- Arrange for regular waste collection before containers overflow.
- Make sure that hazardous waste (e.g., excess oil-based paint and sludge) is collected, removed, and disposed of only at authorized disposal areas.

### Disposal Procedures

- Waste should be disposed of by a licensed hazardous waste transporter at an authorized and licensed disposal facility or recycling facility utilizing properly completed Uniform Hazardous Waste Manifest forms.
- A Department of Health Services certified laboratory should sample waste to determine the appropriate disposal facility.
- Properly dispose of rainwater in secondary containment that may have been mixed with hazardous waste.

### Education

Sources include EPA, SWRCB, Caltrans, CASQA  
**Waste Management**

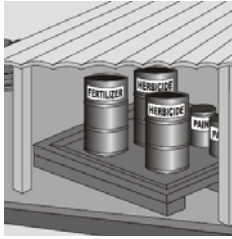

# Waste Management

## WM-7 Hazardous Waste Management

- Educate all employees and subcontractors on hazardous waste storage and disposal procedures.
- Educate employees and subcontractors on potential dangers to humans and the environment from hazardous wastes.
- Instruct employees and subcontractors on safety procedures for common construction site hazardous wastes.
- Instruct employees and subcontractors in identification of hazardous and solid waste.
- Hold regular meetings to discuss and reinforce hazardous waste management procedures (incorporate into regular safety meetings).
- The Contractor's superintendent or representative should oversee and enforce proper hazardous waste management procedures and practices.
- Make sure that hazardous waste is collected, removed, and disposed of only at authorized disposal areas.
- Warning signs should be placed in areas recently treated with chemicals.
- Place a stockpile of spill cleanup materials where it will be readily accessible.
- If a container does spill, clean up immediately.

### Maintenance & Inspection

- Inspect and verify that activity-based BMPs are in place prior to the commencement of associated activities.
- Inspect BMPs prior to forecast rain, daily during extended rain events, after rain events, and weekly throughout the life of the Project.
- Inspect BMPs subject to non-stormwater discharge daily while non-stormwater discharges occur.
- Hazardous waste should be regularly collected.
- A foreman or construction supervisor should monitor onsite hazardous waste storage and disposal procedures.
- Waste storage areas should be kept clean, well organized, and equipped with ample cleanup supplies as appropriate for the materials being stored.
- Perimeter controls, containment structures, covers, and liners should be repaired or replaced as needed to maintain proper function.
- Hazardous spills should be cleaned up and reported in conformance with the applicable Material Safety Data Sheet (MSDS) and the instructions posted at the Project site.
- The National Response Center, at (800) 424-8802, should be notified of spills of federal reportable quantities in conformance with the requirements in 40 CFR Parts 110, 117, and 302. Also notify the Governors Office of Emergency Services Warning Center at (916) 845-8911 and notify UCSB Environmental Health & Safety Department.
- A copy of the hazardous waste manifests should be provided.

Sources include EPA, SWRCB, Caltrans, CASQA  
**Waste Management**

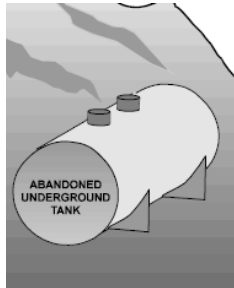

# Waste Management

## WM-8 Contaminated Soil Management

Definition	Conduct pre-construction surveys, inspect excavations regularly, and remediate contaminated soil promptly to prevent or reduce the discharge of pollutants to stormwater from contaminated soil and highly acidic or alkaline soils.
Purpose	Prevent or reduce the discharge of pollutants to stormwater from contaminated soil and highly acidic or alkaline soils.
Conditions Where the Practice Applies	Contaminated soil management is implemented on construction Projects in highly urbanized or industrial areas where soil contamination may have occurred due to spills, illicit discharges, aerial deposition, past use, and leaks from underground storage tanks.
Specifications: Design and Installation	<p>The following steps will help reduce stormwater pollution from contaminated soil:</p> <ul style="list-style-type: none"> <li>• Conduct thorough, pre-construction inspections of the site and review documents related to the site. If inspection or reviews indicated presence of contaminated soils, develop a plan before starting work.</li> <li>• Look for contaminated soil as evidenced by discoloration, odors, differences in soil properties, abandoned underground tanks or pipes, or buried debris.</li> <li>• Prevent leaks and spills. Contaminated soil can be expensive to treat and dispose of properly. However, addressing the problem before construction is much less expensive than after the structures are in place.</li> <li>• The Contractor may further identify contaminated soils by investigating:             <ul style="list-style-type: none"> <li>• Past site uses and activities.</li> <li>• Detected or undetected spills and leaks.</li> <li>• Acid or alkaline solutions from exposed soil or rock formations high in acid or alkaline forming elements.</li> <li>• Contaminated soil as evidenced by discoloration, odors, differences in soil properties, abandoned underground tanks or pipes, or buried debris.</li> </ul> </li> </ul>

### Education

- Have employees and subcontractors complete a safety training program which meets 29 CFR 1910.120 and 8 CCR 5192 covering the potential hazards as identified, prior to performing any excavation work at the locations containing material classified as hazardous.
- Educate employees and subcontractors in identification of contaminated soil and on contaminated soil handling and disposal procedures.
- Hold regular meetings to discuss and reinforce disposal procedures (incorporate into regular safety meetings).

Sources include EPA, SWRCB, Caltrans, CASQA  
**Waste Management**

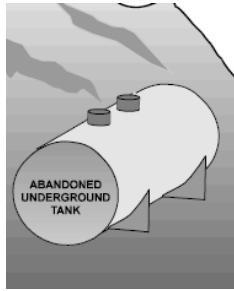

# Waste Management

## WM-8 Contaminated Soil Management

### Handling Procedures for Contaminated Soil

- Minimize onsite storage. Contaminated soil should be disposed of properly in accordance with all applicable regulations. All hazardous waste storage will comply with the requirements in Title 22, CCR, Sections 66265.250 to 66265.260.
- Test suspected soils at an approved certified laboratory.
- Work with the local regulatory agencies to develop options for treatment or disposal if the soil is contaminated.
- Avoid temporary stockpiling of contaminated soils or hazardous material.
- Take the following precautions if temporary stockpiling is necessary:
  - Cover the stockpile with plastic sheeting or tarps.
  - Install a berm around the stockpile to prevent runoff from leaving the area.
  - Do not stockpile in or near stormdrains, watercourses, or the site perimeter.
- Remove contaminated material and hazardous material on exteriors of transport vehicles and place either into the current transport vehicle or into the excavation operations at all locations containing hazardous material.
- Procure all permits and licenses, pay all charges and fees, and give all notices necessary and incident to the due and lawful prosecution of the work, including registration for transporting vehicles carrying the contaminated material and the hazardous material.
- Collect water from decontamination procedures and treat or dispose of it at an appropriate disposal site.
- Collect non-reusable protective equipment, once used by any personnel, and dispose of at an appropriate disposal site.
- Install temporary security fence to surround and secure the exclusion zone. Remove fencing when no longer needed.
- Excavate, transport, and dispose of contaminated material and hazardous material in accordance with the rules and regulations of the following agencies (the specifications of these agencies supersede the procedures outlined in this BMP):
  - United States Department of Transportation (USDOT)
  - United States Environmental Protection Agency (USEPA)
  - California Environmental Protection Agency (CAL-EPA)
  - California Division of Occupation Safety and Health Administration (CAL-OSHA)
  - Local regulatory agencies

### Water Control

- All necessary precautions and preventive measures should be taken to prevent the flow of water, including groundwater, from mixing with hazardous substances or

Sources include EPA, SWRCB, Caltrans, CASQA  
**Waste Management**

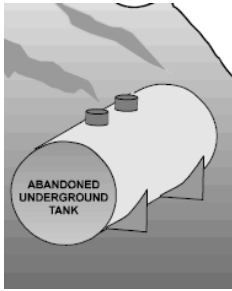

# Waste Management

## WM-8 Contaminated Soil Management

underground storage tank excavations. Such preventative measures may consist of, but are not limited to, berms, cofferdams, grout curtains, freeze walls, and seal course concrete or any combination thereof.

- If water does enter an excavation and becomes contaminated, such water, when necessary to proceed with work, should be discharged to clean, closed top, watertight transportable holding tanks, treated, and disposed of in accordance with federal, state, and local laws.

### Maintenance & Inspection

- Inspect and verify that activity-based BMPs are in place prior to the commencement of associated activities.
- Inspect BMPs prior to forecast rain, daily during extended rain events, after rain events, and weekly throughout the life of the Project.
- Arrange for the Contractor's foreman and/or construction supervisor to monitor onsite contaminated soil storage and disposal procedures.
- Monitor air quality continuously during excavation operations at all locations containing hazardous material.
- Coordinate contaminated soils and hazardous substances/waste management with the appropriate federal, state, and local agencies.